

Stahl

Modul 0,5 – Modul 0,7:

Werkstoff: 11SMnPb30
 gefräste Zähne
 Verzahnungsqualität 8d
 DIN 58405
 geradeverzahnt
 Eingriffswinkel 20°

Modul 1,0:

Werkstoff: 11SMnPb30
 ab 80 Zähne C45
 gefräste Zähne
 Verzahnungsqualität 8d25
 DIN 3967
 geradeverzahnt
 Eingriffswinkel 20°

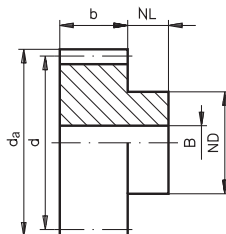

Modul 0,5 – Zahnbreite: 4 mm mit Nabe

Artikel-Nr. mit Nabe	Zähnezahl	b mm	da mm	d mm	NL mm	ND mm	BH ⁷ mm	zul. MD Ncm	Gewicht g
ZSR0501004	10	4	6	5	4	4	2	0,8	0,8
ZSR0501204	12	4	7	6	4	4	2	1	1
ZSR0501304	13	4	7,5	6,5	4	5	2	1,1	1
ZSR0501404	14	4	8	7	4	5	2	1,2	2
ZSR0501504	15	4	8,5	7,5	4	6	3	1,4	2
ZSR0501604	16	4	9	8	4	6	3	1,5	2
ZSR0501704	17	4	9,5	8,5	4	6	3	1,6	2
ZSR0501804	18	4	10	9	4	6	3	1,7	2
ZSR0501904	19	4	10,5	9,5	4	8	3	1,9	3
ZSR0502004	20	4	11	10	4	8	3	2,2	3
ZSR0502104	21	4	11,5	10,5	4	8	3	2,4	4
ZSR0502204	22	4	12	11	4	8	3	2,7	4
ZSR0502304	23	4	12,5	11,5	4	8	3	3	4
ZSR0502404	24	4	13	12	4	8	3	3,3	4
ZSR0502504	25	4	13,5	12,5	4	10	4	3,6	5
ZSR0502604	26	4	14	13	4	10	4	4	5
ZSR0502704	27	4	14,5	13,5	4	10	4	4,3	5
ZSR0502804	28	4	15	14	4	10	4	4,7	6
ZSR0503004	30	4	16	15	4	10	4	5,5	7
ZSR0503204	32	4	17	16	4	12	4	6,3	9
ZSR0503504	35	4	18,5	17,5	4	12	4	7,7	10
ZSR0503604	36	4	19	18	4	12	4	8,2	10
ZSR0503804	38	4	20	19	4	12	4	9,2	11
ZSR0504004	40	4	21	20	4	12	4	10,3	12
ZSR0504204	42	4	22	21	4	15	5	11,5	14
ZSR0504504	45	4	23,5	22,5	4	15	5	13,4	16
ZSR0504804	48	4	25	24	4	15	5	15,5	18
ZSR0505004	50	4	26	25	4	15	5	17	19
ZSR0505204	52	4	27	26	4	15	5	18,5	20
ZSR0505404	54	4	28	27	4	15	5	20,2	22
ZSR0505504	55	4	28,5	27,5	4	15	5	21	23
ZSR0505604	56	4	29	28	4	15	5	21,9	23
ZSR0506004	60	4	31	30	4	20	5	25,5	30
ZSR0506404	64	4	33	32	4	20	5	29,4	33
ZSR0506504	65	4	33,5	32,5	4	20	5	30,5	33
ZSR0507004	70	4	36	35	4	20	5	36	39
ZSR0507204	72	4	37	36	4	20	5	38,3	40
ZSR0507504	75	4	38,5	37,5	4	20	5	42	42
ZSR0508004	80	4	41	40	4	20	5	48,5	47
ZSR0508504	85	4	43,5	42,5	4	25	6	55,6	57
ZSR0509004	90	4	46	45	4	25	6	63,2	62
ZSR0509604	96	4	49	48	4	25	6	73,2	69
ZSR0510004	100	4	51	50	4	25	6	80,2	74
ZSR0511404	114	4	58	57	4	25	6	108	94
ZSR0512004	120	4	61	60	4	25	6	121	100

Tab.55

Modul 0,7 – Zahnbreite: 5 mm mit Nabe

Artikel-Nr. mit Nabe	Zähnezahl	b mm	da mm	d mm	NL mm	ND mm	BH ⁷ mm	zul. MD Ncm	Gewicht g
ZSR0701005	10	5	8,4	7	6	5	3	2	2
ZSR0701205	12	5	9,8	8,4	6	8	3	2,6	3
ZSR0701305	13	5	10,5	9,1	6	8	3	2,9	4
ZSR0701405	14	5	11,2	9,8	6	8	3	3,3	5
ZSR0701505	15	5	11,9	10,5	6	8	3	3,6	5
ZSR0701605	16	5	12,6	11,2	6	10	4	3,8	6
ZSR0701705	17	5	13,3	11,9	6	10	4	4	6
ZSR0701805	18	5	14	12,6	6	10	4	4,5	7
ZSR0701905	19	5	14,7	13,3	6	10	4	5,1	8
ZSR0702005	20	5	15,4	14	6	10	4	5,7	8
ZSR0702105	21	5	16,1	14,7	6	12	4	6,4	10
ZSR0702205	22	5	16,8	15,4	6	12	4	7,1	11
ZSR0702305	23	5	17,5	16,1	6	12	4	7,9	12
ZSR0702405	24	5	18,2	16,8	6	12	4	8,7	13
ZSR0702505	25	5	18,9	17,5	6	15	4	9,5	16
ZSR0702605	26	5	19,6	18,2	6	15	5	10,4	16
ZSR0702705	27	5	20,3	18,9	6	15	5	11,3	17
ZSR0702805	28	5	21	19,6	6	15	5	12,2	18
ZSR0703005	30	5	22,4	21	6	15	5	14,3	20
ZSR0703205	32	5	23,8	22,4	6	15	5	16,5	21
ZSR0703505	35	5	25,9	24,5	6	15	5	20,2	24
ZSR0703605	36	5	26,6	25,2	6	15	5	21,5	26
ZSR0703805	38	5	28	26,6	6	18	5	24,3	31
ZSR0704005	40	5	29,4	28	6	18	5	27,2	33
ZSR0704205	42	5	30,8	29,4	6	18	6	30,4	35
ZSR0704505	45	5	32,9	31,5	6	18	6	35,5	39
ZSR0704805	48	5	35	33,6	6	18	6	41	43
ZSR0705005	50	5	36,4	35	6	18	6	45	46
ZSR0705205	52	5	37,8	36,4	6	18	6	49	49
ZSR0705405	54	5	39,2	37,8	6	18	6	53,4	53
ZSR0705505	55	5	39,9	38,5	6	18	6	55,6	53
ZSR0705605	56	5	40,6	39,2	6	18	6	57,9	56
ZSR0706005	60	5	43,4	42	6	18	6	67,9	63
ZSR0706405	64	5	46,2	44,8	6	18	6	78,2	70
ZSR0706505	65	5	46,9	45,5	6	18	6	81	72
ZSR0707005	70	5	50,4	49	6	18	6	95,8	83
ZSR0707205	72	5	51,8	50,4	6	20	6	102	89
ZSR0707505	75	5	53,9	52,5	6	20	6	112	97
ZSR0708005	80	5	57,4	56	6	20	6	129,5	108
ZSR0708505	85	5	60,9	59,5	6	20	6	149	121
ZSR0709005	90	5	64,4	63	6	20	6	169,5	133
ZSR0709606	96	5	68,6	67,2	6	25	8	196	157
ZSR0710005	100	5	71,4	70	6	25	8	215,5	168
ZSR0711405	114	5	81,2	79,8	6	25	8	291	217
ZSR0712005	120	5	85,4	84	6	25	8	327	239

Tab.56

Modul 1,0 – Zahnbreite: 6,5 mm mit Nabe

Artikel-Nr. mit Nabe	Zähnezahl	b mm	da mm	d mm	NL mm	ND mm	BH ⁷ mm	zul. MD Ncm	Gewicht g
ZSR1001006	10	6,5	12	10	6	8	4	5,5	5
ZSR1001206	12	6,5	14	12	6	10	4	7,3	8
ZSR1001406	14	6,5	16	14	6	10	5	9,2	9
ZSR1001506	15	6,5	17	15	6	10	5	10,1	11
ZSR1001606	16	6,5	18	16	6	12	5	10,8	13
ZSR1001706	17	6,5	19	17	6	12	5	11,2	14
ZSR1001806	18	6,5	20	18	6	15	5	12,7	19
ZSR1002006	20	6,5	22	20	6	15	5	16,3	22
ZSR1002206	22	6,5	24	22	6	15	5	20,3	25
ZSR1002406	24	6,5	26	24	6	15	5	24,7	28
ZSR1002506	25	6,5	27	25	6	15	5	27,1	30
ZSR1002806	28	6,5	30	28	6	15	5	35,1	37
ZSR1003006	30	6,5	32	30	6	15	5	41	41
ZSR1003206	32	6,5	34	32	6	15	5	47,5	46
ZSR1003506	35	6,5	37	35	6	15	5	58,1	54
ZSR1003606	36	6,5	38	36	6	15	5	61,9	57

Modul 1,0 – Zahnbreite: 6,5 mm mit Nabe

Artikel-Nr. mit Nabe	Zähnezahl	b mm	da mm	d mm	NL mm	ND mm	BH ⁷ mm	zul. MD Ncm	Gewicht g
ZSR1004006	40	6,5	42	40	6	18	6	78,6	71
ZSR1004206	42	6,5	44	42	6	18	6	87,7	78
ZSR1004506	45	6,5	47	45	6	18	6	102,5	88
ZSR1004806	48	6,5	50	48	8	18	6	118,7	103
ZSR1005006	50	6,5	52	50	8	18	6	130,2	111
ZSR1005406	54	6,5	56	54	8	18	6	155	127
ZSR1006006	60	6,5	62	60	8	18	6	197	155
ZSR1006406	64	6,5	66	64	8	18	6	228	174
ZSR1006506	65	6,5	67	65	8	18	8	236	175
ZSR1007006	70	6,5	72	70	8	25	8	280	219
ZSR1007206	72	6,5	74	72	10	25	8	298,5	236
ZSR1007506	75	6,5	77	75	10	40	8	328	313
ZSR1008006	80	6,5	82	80	10	40	10	994	342
ZSR1009006	90	6,5	92	90	12	40	10	1190	426
ZSR1010006	100	6,5	102	100	12	40	10	1400	501
ZSR1012006	120	6,5	122	120	12	40	10	1930	674

Tab.57

Stahl

Modul 1,0:
Werkstoff: 11SMnPb30
ab 78 Zähne C 45
gefräste Zähne
Verzahnungsqualität 8d25
DIN 3967
geradeverzahnt
Eingriffswinkel 20°

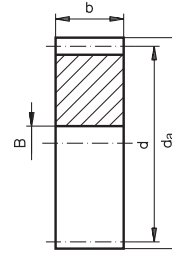
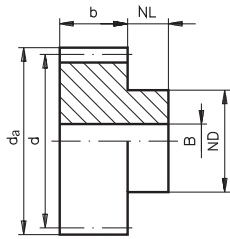

Modul 1,0 – Zahnbreite: 10 mm mit Nabe

Artikel-Nr. mit Nabe	Zähnezahl	b mm	da mm	d mm	NL mm	ND mm	BH7 mm	zul. MD Ncm	Gewicht g
ZSR1001010	10	10	12	10	6	8	4	8	7
ZSR1001110	11	10	13	11	6	8	4	10	8
ZSR1001210	12	10	14	12	6	10	4	11	10
ZSR1001310	13	10	15	13	6	10	5	13	11
ZSR1001410	14	10	16	14	6	10	5	14	14
ZSR1001510	15	10	17	15	6	12	5	15	16
ZSR1001610	16	10	18	16	6	12	5	16	18
ZSR1001710	17	10	19	17	6	12	6	17	19
ZSR1001810	18	10	20	18	6	15	6	19	24
ZSR1001910	19	10	21	19	6	15	6	22	26
ZSR1002010	20	10	22	20	6	15	6	25	28
ZSR1002110	21	10	23	21	6	15	6	28	31
ZSR1002210	22	10	24	22	6	15	6	31	33
ZSR1002310	23	10	25	23	6	15	6	35	36
ZSR1002410	24	10	26	24	6	15	6	38	39
ZSR1002510	25	10	27	25	6	20	8	42	46
ZSR1002610	26	10	28	26	6	20	8	46	49
ZSR1002710	27	10	29	27	6	20	8	50	52
ZSR1002810	28	10	30	28	6	20	8	54	55
ZSR1002910	29	10	31	29	6	20	8	59	59
ZSR1003010	30	10	32	30	8	25	8	63	77
ZSR1003110	31	10	33	31	8	25	8	68	80
ZSR1003210	32	10	34	32	8	25	8	73	85
ZSR1003310	33	10	35	33	8	25	8	79	89
ZSR1003410	34	10	36	34	8	25	8	84	92
ZSR1003510	35	10	37	35	8	25	8	90	96
ZSR1003610	36	10	38	36	8	25	8	96	102
ZSR1003710	37	10	39	37	8	25	8	102	106
ZSR1003810	38	10	40	38	8	25	8	108	110
ZSR1003910	39	10	41	39	8	25	8	114	115
ZSR1004010	40	10	42	40	8	25	8	121	120
ZSR1004110	41	10	43	41	8	25	8	128	125
ZSR1004210	42	10	44	42	8	25	8	135	131
ZSR1004310	43	10	45	43	8	25	8	143	134
ZSR1004410	44	10	46	44	8	25	8	150	140
ZSR1004510	45	10	47	45	10	30	10	158	165
ZSR1004610	46	10	48	46	10	30	10	166	171
ZSR1004810	48	10	50	48	10	30	10	183	182
ZSR1004910	49	10	51	49	10	30	10	192	188
ZSR1005010	50	10	52	50	10	30	10	200	193
ZSR1005210	52	10	54	52	10	40	10	219	249
ZSR1005310	53	10	55	53	10	40	10	228	254
ZSR1005410	54	10	56	54	10	40	10	238	262
ZSR1005510	55	10	57	55	10	40	10	249	269
ZSR1005610	56	10	58	56	10	40	10	259	275
ZSR1005710	57	10	59	57	12	40	10	270	300
ZSR1005810	58	10	60	58	12	40	10	281	307
ZSR1006010	60	10	62	60	12	40	10	303	320
ZSR1006210	62	10	64	62	12	40	10	327	337
ZSR1006410	64	10	66	64	12	40	10	351	352
ZSR1006510	65	10	67	65	12	40	10	364	360
ZSR1006810	68	10	70	68	12	40	10	403	386
ZSR1007010	70	10	72	70	12	40	10	431	401
ZSR1007210	72	10	74	72	12	50	10	459	484
ZSR1007410	74	10	76	74	12	50	10	489	502
ZSR1007510	75	10	77	75	12	50	10	504	510
ZSR1007610	76	10	78	76	12	50	10	520	521
ZSR1007810	78	10	80	78	12	50	10	1400	541
ZSR1008010	80	10	82	80	12	50	10	1450	560
ZSR1008210	82	10	84	82	12	50	10	1500	583
ZSR1008310	83	10	85	83	12	50	10	1530	594
ZSR1008510	85	10	87	85	12	50	10	1590	611
ZSR1008710	87	10	89	87	12	50	10	1650	633
ZSR1009010	90	10	92	90	12	50	12	1750	659
ZSR1009510	95	10	97	95	12	60	12	1900	795
ZSR1010010	100	10	102	100	12	60	12	2070	856
ZSR1011010	110	10	112	110	12	60	12	2650	983
ZSR1011410	114	10	116	114	12	60	12	2730	1036
ZSR1012010	120	10	122	120	12	60	12	2860	1125

Tab.56

Modul 1,0 – Zahnbreite: 10 mm ohne Nabe

Artikel-Nr. ohne Nabe	Zähnezahl	b mm	da mm	d mm	BH7 mm	zul. MD Ncm	Gewicht g
ZSS1001810	18	10	20	18	6	19	17
ZSS1002010	20	10	22	20	6	25	21
ZSS1002110	21	10	23	21	6	28	26
ZSS1002210	22	10	24	22	6	31	26
ZSS1002310	23	10	25	23	6	35	29
ZSS1002410	24	10	26	24	6	38	32
ZSS1002510	25	10	27	25	6	42	35
ZSS1002610	26	10	28	26	6	46	38
ZSS1002710	27	10	29	27	6	50	41
ZSS1002810	28	10	30	28	6	54	44
ZSS1003010	30	10	32	30	8	63	50
ZSS1003210	32	10	34	32	8	73	54
ZSS1003310	33	10	35	33	8	79	61
ZSS1003410	34	10	36	34	8	84	65
ZSS1003510	35	10	37	35	8	90	69
ZSS1003610	36	10	38	36	8	96	74
ZSS1003710	37	10	39	37	8	102	79
ZSS1003810	38	10	40	38	8	108	82
ZSS1003910	39	10	41	39	8	114	87
ZSS1004010	40	10	42	40	8	121	92
ZSS1004110	41	10	43	41	8	128	97
ZSS1004210	42	10	44	42	8	135	101
ZSS1004310	43	10	45	43	8	143	108
ZSS1004410	44	10	46	44	8	150	113
ZSS1004510	45	10	47	45	10	158	116
ZSS1004610	46	10	48	46	10	166	121
ZSS1004710	47	10	49	47	10	174	128
ZSS1004810	48	10	50	48	10	183	133
ZSS1004910	49	10	51	49	10	192	139
ZSS1005010	50	10	52	50	10	200	145
ZSS1005110	51	10	53	51	10	208	152
ZSS1005210	52	10	54	52	10	219	157
ZSS1005310	53	10	55	53	10	229	163
ZSS1005410	54	10	56	54	10	239	170
ZSS1005510	55	10	57	55	10	249	176
ZSS1005610	56	10	58	56	10	259	183
ZSS1005910	59	10	61	59	10	292	204
ZSS1006010	60	10	62	60	10	303	212
ZSS1006110	61	10	63	61	10	315	218
ZSS1006310	63	10	65	63	10	339	234
ZSS1006410	64	10	66	64	10	351	242
ZSS1006510	65	10	67	65	10	364	249
ZSS1006610	66	10	68	66	10	378	260
ZSS1006710	67	10	69	67	10	385	265
ZSS1006810	68	10	70	68	10	403	274
ZSS1006910	69	10	71	69	10	417	283
ZSS1007010	70	10	72	70	10	431	290
ZSS1007110	71	10	73	71	10	445	301
ZSS1007210	72	10	74	72	10	459	309
ZSS1007310	73	10	75	73	10	474	317
ZSS1007510	75	10	77	75	10	504	334
ZSS1007610	76	10	78	76	10	520	343
ZSS1007710	77	10	79	77	10	536	351
ZSS1007810	78	10	80	78	10	1400	366
ZSS1007910	79	10	81	79	10	1425	373
ZSS1008010	80	10	82	80	10	1450	384
ZSS1008210	82	10	84	82	10	1500	401
ZSS1008410	84	10	86	84	10	1560	423
ZSS1008510	85	10	87	85	12	1590	427
ZSS1009010	90	10	92	90	12	1750	486
ZSS1009210	92	10	94	92	12	1810	508
ZSS1009610	96	10	98	96	12	1940	550
ZSS1010010	100	10	102	100	12	2070	601
ZSS1010510	105	10	107	105	12	2550	662
ZSS1011010	110	10	112	110	12	2650	728
ZSS1011410	114	10	116	114	12	2730	783
ZSS1012010	120	10	122	120	12	2860	870
ZSS1012410	124	10	126	124	12	2910	934

Tab.59

Stahl

Modul 1,0:

Werkstoff: C45
gefräste Zähne
Verzahnungsqualität 8d25
DIN 3967
geradeverzahnt
Eingriffswinkel 20°

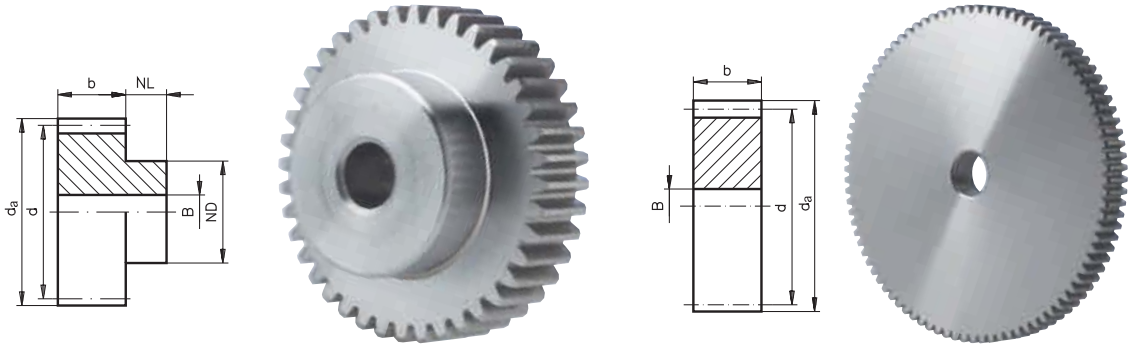

Modul 1,0 – Zahnbreite: 15 mm mit Nabe

Artikel-Nr. mit Nabe	Zähne- zahl	b mm	da mm	d mm	NL mm	ND mm	BH7 mm	zul. MD Ncm	Gewicht g
ZSR1001115	11	15	13	11	10	8	5	30	12
ZSR1001215	12	15	14	12	10	9	6	35	10
ZSR1001315	13	15	15	13	10	10	6	40	20
ZSR1001415	14	15	16	14	10	11	6	45	20
ZSR1001515	15	15	17	15	10	12	6	49	20
ZSR1001615	16	15	18	16	10	13	6	53	30
ZSR1001715	17	15	19	17	10	14	6	55	30
ZSR1001815	18	15	20	18	10	15	8	62	30
ZSR1001915	19	15	21	19	10	15	8	72	40
ZSR1002015	20	15	22	20	10	16	8	81	40
ZSR1002115	21	15	23	21	10	16	8	91	50
ZSR1002215	22	15	24	22	10	16	8	101	50
ZSR1002315	23	15	25	23	10	18	8	112	60
ZSR1002415	24	15	26	24	10	20	10	125	60
ZSR1002515	25	15	27	25	10	20	10	136	70
ZSR1002615	26	15	28	26	10	20	10	150	70
ZSR1002715	27	15	29	27	10	20	10	164	80
ZSR1002815	28	15	30	28	10	20	10	177	80
ZSR1002915	29	15	31	29	10	20	10	195	90
ZSR1003015	30	15	32	30	10	20	10	209	90
ZSR1003115	31	15	33	31	10	25	10	224	110
ZSR1003215	32	15	34	32	10	25	10	243	120
ZSR1003315	33	15	35	33	10	25	10	262	120
ZSR1003415	34	15	36	34	10	25	10	279	130
ZSR1003515	35	15	37	35	10	25	10	299	140
ZSR1003615	36	15	38	36	10	25	10	318	140
ZSR1003715	37	15	39	37	10	25	10	329	150
ZSR1003815	38	15	40	38	10	25	10	364	160
ZSR1003915	39	15	41	39	10	25	10	385	160
ZSR1004015	40	15	42	40	10	25	10	409	170
ZSR1004115	41	15	43	41	10	30	10	436	190
ZSR1004215	42	15	44	42	10	30	10	459	200
ZSR1004315	43	15	45	43	10	30	10	486	210
ZSR1004415	44	15	46	44	10	30	10	511	220
ZSR1004515	45	15	47	45	10	30	10	538	230
ZSR1004615	46	15	48	46	10	30	10	566	230
ZSR1004715	47	15	49	47	10	30	10	602	240
ZSR1004815	48	15	50	48	10	30	10	642	250
ZSR1004915	49	15	51	49	10	30	10	682	260
ZSR1005015	50	15	52	50	10	30	12	725	260
ZSR1005115	51	15	53	51	10	40	12	769	320
ZSR1005215	52	15	54	52	10	40	12	818	330
ZSR1005315	53	15	55	53	10	40	12	843	330
ZSR1005415	54	15	56	54	10	40	12	893	340
ZSR1005515	55	15	57	55	10	40	12	934	360
ZSR1005615	56	15	58	56	10	40	12	972	370
ZSR1005715	57	15	59	57	10	40	12	1013	380
ZSR1005815	58	15	60	58	10	40	12	1054	390
ZSR1005915	59	15	61	59	10	40	12	1101	400
ZSR1006015	60	15	62	60	10	40	12	1146	410
ZSR1006115	61	15	63	61	10	50	12	1196	470
ZSR1006215	62	15	64	62	10	50	12	1265	490
ZSR1006315	63	15	65	63	10	50	12	1330	500
ZSR1006415	64	15	66	64	10	50	12	1395	510
ZSR1006515	65	15	67	65	10	50	12	1459	520
ZSR1006615	66	15	68	66	10	50	12	1503	530
ZSR1006715	67	15	69	67	10	50	12	1548	550
ZSR1006815	68	15	70	68	10	50	12	1592	560
ZSR1006915	69	15	71	69	10	50	12	1630	570
ZSR1007015	70	15	72	70	10	50	12	1665	580

Tab.60

Modul 1,0 – Zahnbreite: 15 mm ohne Nabe

Artikel-Nr. ohne Nabe	Zähne- zahl	b mm	da mm	d mm	BH7 mm	zul. MD Ncm	Gewicht g
ZSS1001815	18	15	20	18	8	62	24
ZSS1002015	20	15	22	20	8	81	30
ZSS1002415	24	15	26	24	10	125	43
ZSS1002515	25	15	27	25	10	136	48
ZSS1003015	30	15	32	30	10	209	72
ZSS1003515	35	15	37	35	10	299	102
ZSS1003615	36	15	38	36	10	318	108
ZSS1004015	40	15	42	40	10	409	136
ZSS1004515	45	15	47	45	10	538	174
ZSS1004815	48	15	50	48	10	642	200
ZSS1005015	50	15	52	50	12	725	214
ZSS1005215	52	15	54	52	12	818	232
ZSS1006015	60	15	62	60	12	1146	313
ZSS1007215	72	15	74	72	12	1729	460
ZSS1007515	75	15	77	75	12	1838	510
ZSS1007615	76	15	78	76	12	1872	520
ZSS1008015	80	15	82	80	12	2030	580
ZSS1008515	85	15	87	85	12	2230	650
ZSS1009015	90	15	92	90	12	2450	730
ZSS1009515	95	15	97	95	12	2660	820
ZSS1010015	100	15	102	100	12	2890	910
ZSS1011015	110	15	112	110	12	3710	100
ZSS1011415	114	15	116	114	12	3820	190
ZSS1012015	120	15	122	120	12	4000	1320
ZSS1012715	127	15	129	127	12	4200	1470

Tab.61

Stahl

Modul 1,25:
Werkstoff: 11SMnPb30
ab 64 Zähne C45
gefräste Zähne
Verzahnungsqualität 8d25
DIN 3967
geradeverzahnt
Eingriffswinkel 20°

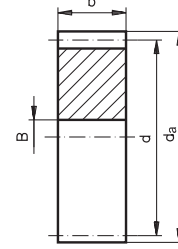
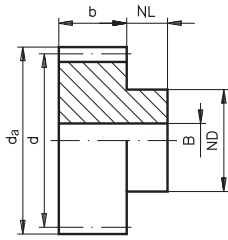

Modul 1,25 – Zahnbreite: 10 mm mit Nabe

Artikel-Nr. mit Nabe	Zähnezahl	b mm	da mm	d mm	NL mm	ND mm	BH7 mm	zul. MD Ncm	Gewicht g
ZSR1201210	12	10	17,5	15	10	12	5	19	19
ZSR1201310	13	10	18,75	16,25	10	12	5	21	21
ZSR1201410	14	10	20	17,5	10	12	5	23	24
ZSR1201510	15	10	21,25	18,75	10	15	6	26	30
ZSR1201610	16	10	22,5	20	10	15	6	27	33
ZSR1201710	17	10	23,75	21,25	10	15	6	28	36
ZSR1201810	18	10	25	22,5	10	15	6	32	40
ZSR1201910	19	10	26,25	23,75	10	15	6	37	43
ZSR1202010	20	10	27,5	25	10	15	6	41	46
ZSR1202110	21	10	28,75	26,25	10	15	6	46	50
ZSR1202210	22	10	30	27,5	10	20	8	51	61
ZSR1202310	23	10	31,25	28,75	10	20	8	57	66
ZSR1202410	24	10	32,5	30	10	20	8	63	70
ZSR1202510	25	10	33,75	31,25	10	20	8	69	75
ZSR1202610	26	10	35	32,5	10	20	8	75	80
ZSR1202710	27	10	36,25	33,75	10	20	8	82	88
ZSR1202810	28	10	37,5	35	10	20	8	89	90
ZSR1203010	30	10	40	37,5	10	25	10	104	111
ZSR1203210	32	10	42,5	40	10	25	10	121	121
ZSR1203510	35	10	46,25	43,75	10	25	10	148	140
ZSR1203610	36	10	47,5	45	10	25	10	158	147
ZSR1203710	37	10	48,75	46,25	10	25	10	168	154
ZSR1203810	38	10	50	47,5	10	30	10	178	179
ZSR1204010	40	10	52,5	50	12	30	10	200	204
ZSR1204210	42	10	55	52,5	12	30	10	224	218
ZSR1204510	45	10	58,75	56,25	12	30	10	261	244
ZSR1204810	48	10	62,5	60	12	30	10	303	268
ZSR1205010	50	10	65	62,5	12	30	10	332	291
ZSR1205210	52	10	67,5	65	12	30	10	363	307
ZSR1205410	54	10	70	67,5	12	40	10	396	380
ZSR1205510	55	10	71,25	68,75	12	40	10	413	392
ZSR1205610	56	10	72,5	70	12	40	10	430	402
ZSR1205710	57	10	73,75	71,25	12	40	10	448	407
ZSR1206010	60	10	77,5	75	12	40	10	504	444
ZSR1206410	64	10	82,5	80	12	40	10	1700	491
ZSR1206510	65	10	83,75	81,25	12	40	10	1760	507
ZSR1207010	70	10	90	87,5	12	40	12	2090	566
ZSR1207210	72	10	92,5	90	12	40	12	2220	594
ZSR1207510	75	10	96,25	93,75	12	40	12	2360	634
ZSR1207610	76	10	97,5	95	12	50	12	2410	712
ZSR1208010	80	10	102,5	100	12	50	12	2600	772
ZSR1208510	85	10	108,75	106,25	12	50	12	2850	868
ZSR1209010	90	10	115	112,5	12	50	12	3110	938
ZSR1210010	100	10	127,5	125	12	50	12	3960	1119
ZSR1212010	120	10	152,5	150	12	50	12	4390	1537

Tab.62

Modul 1,25 – Zahnbreite: 10 mm ohne Nabe

Artikel-Nr. ohne Nabe	Zähnezahl	b mm	da mm	d mm	BH7 mm	zul. MD Ncm	Gewicht g
ZSS1201610	16	10	22,5	20	6	27	21
ZSS1201710	17	10	23,75	21,25	6	28	25
ZSS1201910	19	10	26,25	23,75	6	32	32
ZSS1202010	20	10	27,5	25	6	41	35
ZSS1202110	21	10	28,75	26,25	6	46	40
ZSS1202210	22	10	30	27,5	6	51	43
ZSS1202310	23	10	31,25	28,75	6	57	48
ZSS1202410	24	10	32,5	30	8	63	50
ZSS1202510	25	10	33,75	31,25	8	69	55
ZSS1202610	26	10	35	32,5	8	75	59
ZSS1202710	27	10	36,25	33,75	8	82	64
ZSS1202810	28	10	37,5	35	8	89	70
ZSS1203010	30	10	40	37,5	10	104	81
ZSS1203210	32	10	42,5	40	10	121	90
ZSS1203410	34	10	45	42,5	10	138	103
ZSS1203510	35	10	46,25	43,75	10	148	109
ZSS1203610	36	10	47,5	45	10	158	117
ZSS1203810	38	10	50	47,5	10	178	129
ZSS1204010	40	10	52,5	50	10	200	144
ZSS1204210	42	10	55	52,5	10	224	159
ZSS1204510	45	10	58,75	56,25	10	261	184
ZSS1204810	48	10	62,5	60	10	303	209
ZSS1205010	50	10	65	62,5	10	332	229
ZSS1205210	52	10	67,5	65	10	363	250
ZSS1205410	54	10	70	67,5	10	396	267
ZSS1205510	55	10	71,25	68,75	10	413	278
ZSS1205610	56	10	72,5	70	10	430	291
ZSS1205710	57	10	73,75	71,25	10	448	300
ZSS1206010	60	10	77,5	75	10	504	334
ZSS1206410	64	10	82,5	80	10	1700	384
ZSS1206510	65	10	83,75	81,25	10	1760	396
ZSS1207010	70	10	90	87,5	12	2090	460
ZSS1207210	72	10	92,5	90	12	2220	488
ZSS1207510	75	10	96,25	93,75	12	2360	525
ZSS1207610	76	10	97,5	95	12	2410	540
ZSS1208010	80	10	102,5	100	12	2600	601
ZSS1208510	85	10	108,75	106,25	12	2850	679
ZSS1209010	90	10	115	112,5	12	3110	758
ZSS1209510	95	10	121,25	118,75	12	3810	842
ZSS1210010	100	10	127,5	125	15	3960	940
ZSS1211410	114	10	145	142,5	15	4300	1220
ZSS1212010	120	10	152,5	150	20	4390	1335

Tab.63

Stahl

Modul 1,5: ab 55 Zähne C45

Modul 1,5 – Zahnbreite: 10 mm mit Nabe

Artikel-Nr. mit Nabe	Zähnezahl	b mm	da mm	d mm	NL mm	ND mm	BH7 mm	zul. MD Ncm	Gewicht g
ZSR1501210	12	10	21	18	10	15	8	27,5	24
ZSR1501510	15	10	25,5	22,5	10	18	10	38	37
ZSR1501810	18	10	30	27	10	22	10	47,5	61
ZSR1502010	20	10	33	30	10	25	10	61,5	79
ZSR1502410	24	10	39	36	10	25	10	94	101
ZSR1502510	25	10	40,5	37,5	10	25	10	103	110
ZSR1502810	28	10	45	42	10	25	10	134	131
ZSR1503010	30	10	48	45	10	25	10	156,5	148
ZSR1503210	32	10	51	48	10	25	10	181,5	164
ZSR1503510	35	10	55,5	52,5	10	25	10	222,5	204

Modul 1,5 – Zahnbreite: 10 mm ohne Nabe

Artikel-Nr. ohne Nabe	Zähnezahl	b mm	da mm	d mm	NL mm	ND mm	BH7 mm	zul. MD Ncm	Gewicht g
ZSR1504010	40	10	63	60	10	25	10	302	242
ZSR1504210	42	10	66	63	10	25	10	338	267
ZSR1504510	45	10	70,5	67,5	10	25	10	395,5	301
ZSR1504810	48	10	75	72	10	25	10	459	339
ZSR1505010	50	10	78	75	10	30	10	503,5	382
ZSR1505510	55	10	85,5	82,5	10	30	10	1820	460
ZSR1506010	60	10	93	90	10	30	10	2230	535
ZSR1506510	65	10	100,5	97,5	15	45	12	2830	742
ZSR1507010	70	10	108	105	15	45	12	3430	839
ZSR1508010	80	10	123	120	15	45	12	4150	1041

Tab.64

Stahl

Modul 1,5:

Werkstoff: 11SMnPb30
ab 52 Zähne C45
gefärbte Zähne
Verzahnungsqualität 8d25
DIN 3967
geradeverzahnt
Eingriffswinkel 20°

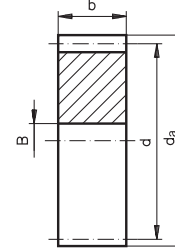
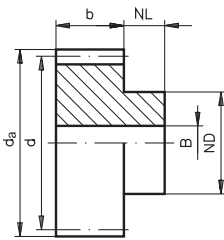

Modul 1,5 – Zahnbreite: 15 mm mit Nabe

Artikel-Nr. mit Nabe	Zähne- zahl	b mm	da mm	d mm	NL mm	ND mm	BH7 mm	zul. MD Ncm	Gewicht g
ZSR1501115	11	15	19,5	16,5	10	12	6	35	28
ZSR1501215	12	15	21	18	10	15	8	41	32
ZSR1501315	13	15	22,5	19,5	10	15	8	47	37
ZSR1501415	14	15	24	21	10	15	8	52	42
ZSR1501515	15	15	25,5	22,5	10	18	10	57	49
ZSR1501615	16	15	27	24	10	20	10	62	60
ZSR1501715	17	15	28,5	25,5	10	20	10	67	66
ZSR1501815	18	15	30	27	10	22	10	72	79
ZSR1501915	19	15	31,5	28,5	10	25	10	82	95
ZSR1502015	20	15	33	30	10	25	10	92	103
ZSR1502115	21	15	34,5	31,5	15	25	10	103	128
ZSR1502215	22	15	36	33	15	25	10	115	136
ZSR1502315	23	15	37,5	34,5	15	25	10	128	145
ZSR1502415	24	15	39	36	15	25	10	141	154
ZSR1502515	25	15	40,5	37,5	15	25	10	155	166
ZSR1502615	26	15	42	39	15	25	10	169	175
ZSR1502715	27	15	43,5	40,5	15	25	10	185	185
ZSR1502815	28	15	45	42	15	25	10	201	198
ZSR1503015	30	15	48	45	15	30	10	235	246
ZSR1503215	32	15	51	48	15	30	10	272	273
ZSR1503415	34	15	54	51	15	30	10	313	298
ZSR1503515	35	15	55,5	52,5	15	30	10	334	317
ZSR1503615	36	15	57	54	15	40	10	356	392
ZSR1503815	38	15	60	57	15	40	10	403	422
ZSR1504015	40	15	63	60	15	40	10	453	454
ZSR1504215	42	15	66	63	15	40	10	507	488
ZSR1504415	44	15	69	66	15	40	10	564	523
ZSR1504515	45	15	70,5	67,5	15	40	10	593	541
ZSR1504615	46	15	72	69	15	40	10	624	560
ZSR1504815	48	15	75	72	15	40	10	688	599
ZSR1505015	50	15	78	75	15	50	10	755	721
ZSR1505215	52	15	81	78	15	50	10	2400	765
ZSR1505415	54	15	84	81	15	50	10	2620	810
ZSR1505515	55	15	85,5	82,5	15	50	10	2740	831
ZSR1505615	56	15	87	84	15	50	10	2850	855
ZSR1505715	57	15	88,5	85,5	15	50	10	2970	880
ZSR1505815	58	15	90	87	15	50	10	3090	905
ZSR1506015	60	15	93	90	15	60	12	3360	1041
ZSR1506215	62	15	96	93	15	60	12	3710	1096
ZSR1506315	63	15	97,5	94,5	15	60	12	3900	1122
ZSR1506415	64	15	99	96	15	60	12	4090	1148
ZSR1506515	65	15	100,5	97,5	15	60	12	4280	1172
ZSR1506815	68	15	105	102	15	60	12	4670	1254
ZSR1507015	70	15	108	105	20	60	12	4870	1423
ZSR1507215	72	15	111	108	20	70	12	5070	1683
ZSR1507415	74	15	114	110	20	70	12	5280	1716
ZSR1507515	75	15	115,5	112,5	20	70	12	5390	1726
ZSR1507615	76	15	117	114	20	70	15	5490	1746
ZSR1507815	78	15	120	117	20	70	15	5710	1782
ZSR1508015	80	15	123	120	20	70	15	5920	1878
ZSR1508215	82	15	126	123	20	70	15	6100	1941
ZSR1508515	85	15	130,5	127,5	20	70	15	7330	2038
ZSR1509015	90	15	138	135	20	70	15	7710	2221
ZSR1509515	95	15	145,5	142,5	20	70	15	8080	2398
ZSR1510015	100	15	153	150	20	70	15	8380	2620
ZSR1511415	114	15	174	171	20	70	20	8750	3166
ZSR1512015	120	15	183	180	20	70	20	9160	3468

Tab.65

Modul 1,5 – Zahnbreite: 15 mm ohne Nabe

Artikel-Nr. ohne Nabe	Zähne- zahl	b mm	da mm	d mm	BH7 mm	zul. MD Ncm	Gewicht g
ZSS1501815	18	15	30	27	8	72	60
ZSS1502015	20	15	33	30	8	92	75
ZSS1502115	21	15	34,5	31,5	8	103	83
ZSS1502315	23	15	37,5	34,5	8	128	101
ZSS1502415	24	15	39	36	8	141	110
ZSS1502515	25	15	40,5	37,5	8	155	120
ZSS1502615	26	15	42	39	8	169	131
ZSS1502715	27	15	43,5	40,5	8	185	141
ZSS1502815	28	15	45	42	10	201	149
ZSS1502915	29	15	46,5	43,5	10	218	161
ZSS1503015	30	15	48	45	10	235	174
ZSS1503215	32	15	51	48	10	272	199
ZSS1503315	33	15	52,5	49,5	10	292	212
ZSS1503515	35	15	55,5	52,5	10	334	240
ZSS1503615	36	15	57	54	10	356	255
ZSS1503715	37	15	58,5	55,5	10	379	267
ZSS1503815	38	15	60	57	10	403	284
ZSS1503915	39	15	61,5	58,5	10	428	300
ZSS1504015	40	15	63	60	10	453	316
ZSS1504115	41	15	64,5	61,5	10	480	336
ZSS1504315	43	15	67,5	64,5	10	535	367
ZSS1504515	45	15	70,5	67,5	10	593	403
ZSS1504715	47	15	73,5	70,5	10	656	441
ZSS1504815	48	15	75	72	10	688	460
ZSS1505015	50	15	78	75	10	755	500
ZSS1505115	51	15	79,5	76,5	10	790	525
ZSS1505215	52	15	81	78	10	2400	545
ZSS1505315	53	15	82,5	79,5	10	2510	574
ZSS1505415	54	15	84	81	12	2620	585
ZSS1505515	55	15	85,5	82,5	12	2740	607
ZSS1505615	56	15	87	84	12	2850	629
ZSS1506015	60	15	93	90	12	3360	726
ZSS1506415	64	15	99	96	12	4090	832
ZSS1506515	65	15	100,5	97,5	12	4280	850
ZSS1506715	67	15	103,5	100,5	12	4570	909
ZSS1507015	70	15	108	105	12	4870	990
ZSS1507115	71	15	109,5	106,5	12	4970	1022
ZSS1507215	72	15	111	108	12	5070	1051
ZSS1507515	75	15	115,5	112,5	12	5390	1146
ZSS1507615	76	15	117	114	15	5490	1166
ZSS1508015	80	15	123	120	15	5920	1298
ZSS1508515	85	15	130,5	127,5	15	7330	1455
ZSS1508815	88	15	135	132	15	7560	1576
ZSS1509015	90	15	138	135	15	7710	1659
ZSS1509515	95	15	145,5	142,5	15	8080	1825
ZSS1509615	96	15	147	144	15	8150	1878
ZSS1510015	100	15	153	150	15	8380	2048
ZSS1511015	110	15	168	165	20	8620	2465
ZSS1511415	114	15	174	171	20	8750	2647
ZSS1512015	120	15	183	180	20	9160	2939

Tab.66

Stahl

Modul 1,5:
Werkstoff: C45
gefräste Zähne
Verzahnungsqualität 8d25
DIN 3967
geradeverzahnt
Eingriffswinkel 20°

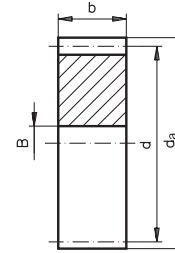
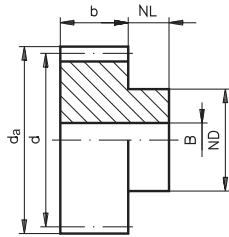

Modul 1,5 – Zahnbreite: 17 mm mit Nabe

Artikel-Nr. mit Nabe	Zähnezahl	b mm	da mm	d mm	NL mm	ND mm	BH7 mm	zul. MD Ncm	Gewicht g
ZSR1501117	11	17	19,5	16,5	13	12	6	99	33
ZSR1501217	12	17	21	18	13	14	8	114	40
ZSR1501317	13	17	22,5	19,5	13	15	8	130	50
ZSR1501417	14	17	24	21	13	17	8	146	60
ZSR1501517	15	17	25,5	22,5	13	18	8	158	70
ZSR1501617	16	17	27	24	13	19	8	171	80
ZSR1501717	17	17	28,5	25,5	13	20	8	179	90
ZSR1501817	18	17	30	27	13	20	8	199	100
ZSR1501917	19	17	31,5	28,5	13	20	8	231	100
ZSR1502017	20	17	33	30	13	25	8	260	130
ZSR1502117	21	17	34,5	31,5	13	25	10	292	130
ZSR1502217	22	17	36	33	13	25	10	325	140
ZSR1502317	23	17	37,5	34,5	13	25	10	361	160
ZSR1502417	24	17	39	36	13	25	10	402	170
ZSR1502517	25	17	40,5	37,5	13	25	10	438	180
ZSR1502617	26	17	42	39	13	30	12	483	200
ZSR1502717	27	17	43,5	40,5	13	30	12	528	220
ZSR1502817	28	17	45	42	13	30	12	572	230
ZSR1502917	29	17	46,5	43,5	13	30	12	629	240
ZSR1503017	30	17	48	45	13	30	12	674	260
ZSR1503117	31	17	49,5	46,5	13	35	12	723	300
ZSR1503217	32	17	51	48	13	35	12	784	310
ZSR1503317	33	17	52,5	49,5	13	35	12	844	330
ZSR1503417	34	17	54	51	13	35	12	901	340
ZSR1503517	35	17	55,5	52,5	13	35	12	966	360
ZSR1503617	36	17	57	54	13	35	12	1027	370
ZSR1503717	37	17	58,5	55,5	13	40	12	1060	420
ZSR1503817	38	17	60	57	13	40	12	1173	440
ZSR1503917	39	17	61,5	58,5	13	40	12	1242	460
ZSR1504017	40	17	63	60	13	40	12	1320	480
ZSR1504117	41	17	64,5	61,5	13	40	12	1405	500
ZSR1504217	42	17	66	63	13	50	12	1482	590
ZSR1504317	43	17	67,5	64,5	13	50	12	1567	610
ZSR1504417	44	17	69	66	13	50	12	1648	630
ZSR1504517	45	17	70,5	67,5	13	50	12	1734	650
ZSR1504617	46	17	72	69	13	50	14	1827	660
ZSR1504717	47	17	73,5	70,5	13	50	14	1941	700
ZSR1504817	48	17	75	72	13	50	14	2071	700
ZSR1504917	49	17	76,5	73,5	13	50	14	2200	730
ZSR1505017	50	17	78	75	13	50	14	2339	760
ZSR1505117	51	17	79,5	76,5	13	60	14	2480	860
ZSR1505217	52	17	81	78	13	60	14	2640	890
ZSR1505317	53	17	82,5	79,5	13	60	14	2720	910
ZSR1505417	54	17	84	81	13	60	14	2882	940
ZSR1505517	55	17	85,5	82,5	13	60	14	3014	960
ZSR1505617	56	17	87	84	13	60	16	3135	980
ZSR1505717	57	17	88,5	85,5	13	60	16	3267	1000
ZSR1505817	58	17	90	87	13	60	16	3399	1030
ZSR1505917	59	17	91,5	88,5	13	60	16	3551	1060
ZSR1506017	60	17	93	90	13	60	16	3696	1090
ZSR1506117	61	17	94,5	91,5	13	70	16	3858	1220
ZSR1506217	62	17	96	93	13	70	16	4081	1250
ZSR1506317	63	17	97,5	94,5	13	70	16	4290	1280
ZSR1506417	64	17	99	96	13	70	16	4499	1310
ZSR1506517	65	17	100,5	97,5	13	70	16	4708	1340
ZSR1506617	66	17	102	99	13	70	16	4848	1370
ZSR1506717	67	17	103,5	100,5	13	70	16	4993	1400
ZSR1506817	68	17	105	102	13	70	16	5137	1430
ZSR1506917	69	17	106,5	103,5	13	70	16	5257	1460
ZSR1507017	70	17	108	105	13	70	16	5370	1500
ZSR1507217	72	17	111	108	13	80	16	5577	1660
ZSR1507517	75	17	115,5	112,5	13	80	16	5929	1760
ZSR1508017	80	17	123	120	13	80	16	6512	1940
ZSR1509017	90	17	138	135	13	80	16	8481	2330
ZSR1510017	100	17	153	150	13	80	16	9218	2770
ZSR1512017	120	17	183	180	13	80	16	10076	3790

Tab.67

Modul 1,5 – Zahnbreite: 17 mm ohne Nabe

Artikel-Nr. ohne Nabe	Zähnezahl	b mm	da mm	d mm	BH7 mm	zul. MD Ncm	Gewicht g
ZSS1501817	18	17	30	27	8	199	68
ZSS1502017	20	17	33	30	8	260	86
ZSS1502417	24	17	39	36	10	402	123
ZSS1502517	25	17	40,5	37,5	10	438	135
ZSS1503017	30	17	48	45	12	674	195
ZSS1503517	35	17	55,5	52,5	12	966	270
ZSS1503617	36	17	57	54	12	1027	285
ZSS1504017	40	17	63	60	12	1320	355
ZSS1504517	45	17	70,5	67,5	12	1734	455
ZSS1504817	48	17	75	72	14	2071	510
ZSS1505017	50	17	78	75	14	2339	560
ZSS1506017	60	17	93	90	16	3696	810
ZSS1507217	72	17	111	108	16	5577	1190
ZSS1507517	75	17	115,5	112,5	16	5929	1300
ZSS1507617	76	17	117	114	16	6039	1330
ZSS1508017	80	17	123	120	16	6512	1480
ZSS1508517	85	17	130,5	127,5	16	8063	1670
ZSS1509017	90	17	138	135	16	8481	1880
ZSS1509517	95	17	145,5	142,5	16	8888	2090
ZSS1510017	100	17	153	150	16	9218	2320
ZSS1511017	110	17	168	165	16	9416	2820
ZSS1511417	114	17	174	171	16	9620	3030
ZSS1512017	120	17	183	180	16	10076	3360
ZSS1512717	127	17	193,5	190,5	16	10705	3770

Tab.68

Stahl

Modul 2,0:

Werkstoff: 11SMnPb30
ab 38 Zähne C45
gefärbte Zähne
Verzahnungsqualität 8d25
DIN 3967
geradeverzahnt
Eingriffswinkel 20°

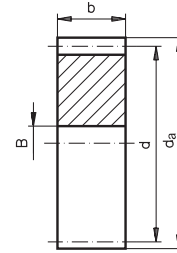
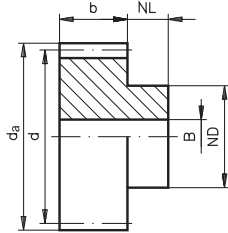

Modul 2,0 – Zahnbreite: 16 mm ohne Nabe

Artikel-Nr. ohne Nabe	Zähne- zahl	b mm	da mm	d mm	NL mm	ND mm	BH7 mm	zul. MD Nm	Gewicht g
ZSR2001016	10	16	24	20	15	15	8	0,6	45
ZSR2001216	12	16	28	24	15	20	10	0,8	70
ZSR2001316	13	16	30	26	15	20	10	0,9	81
ZSR2001416	14	16	32	28	15	25	10	1,1	110
ZSR2001516	15	16	34	30	15	25	12	1,2	114
ZSR2001616	16	16	36	32	15	25	12	1,3	126
ZSR2001716	17	16	38	34	15	25	12	1,4	139
ZSR2001816	18	16	40	36	15	30	12	1,5	179
ZSR2001916	19	16	42	38	15	30	12	1,7	192
ZSR2002016	20	16	44	40	15	30	12	1,9	207
ZSR2002116	21	16	46	42	15	30	12	2,1	224
ZSR2002216	22	16	48	44	15	30	12	2,3	240
ZSR2002316	23	16	50	46	15	30	12	2,6	257
ZSR2002416	24	16	52	48	15	30	12	2,9	275
ZSR2002516	25	16	54	50	15	30	12	3,2	295
ZSR2002616	26	16	56	52	15	35	12	3,5	344
ZSR2002716	27	16	58	54	15	35	12	3,8	364
ZSR2002816	28	16	60	56	15	35	12	4,1	386
ZSR2002916	29	16	62	58	15	35	12	4,5	409
ZSR2003016	30	16	64	60	15	40	12	4,8	466
ZSR2003116	31	16	66	62	15	40	12	5,2	489
ZSR2003216	32	16	68	64	15	40	12	5,6	514
ZSR2003416	34	16	72	68	15	40	12	6,4	566
ZSR2003516	35	16	74	70	15	45	12	6,9	632
ZSR2003616	36	16	76	72	15	45	12	7,3	659
ZSR2003716	37	16	78	74	15	45	12	7,8	689
ZSR2003816	38	16	80	76	15	45	12	24,1	720
ZSR2003916	40	16	84	80	15	50	12	27,1	825
ZSR2004216	42	16	88	84	15	50	12	30,4	891
ZSR2004416	44	16	92	88	15	50	12	33,8	955
ZSR2004516	45	16	94	90	15	50	12	35,6	991
ZSR2004616	46	16	96	92	15	50	12	37,5	1025
ZSR2004716	47	16	98	94	15	50	12	39,8	1066
ZSR2004816	48	16	100	96	15	50	12	42,5	1098
ZSR2005016	50	16	104	100	15	50	12	48	1174
ZSR2005216	52	16	108	104	15	60	12	54	1357
ZSR2005316	53	16	110	106	15	60	12	57,1	1396
ZSR2005416	54	16	112	108	15	60	12	60,3	1442
ZSR2005516	55	16	114	110	15	60	12	63,6	1485
ZSR2005616	56	16	116	112	15	60	12	67,1	1527
ZSR2005716	57	16	118	114	15	70	12	70,6	1688
ZSR2005816	58	16	120	116	15	70	12	74,2	1737
ZSR2005916	59	16	122	118	15	70	12	77,6	1784
ZSR2006016	60	16	124	120	15	70	12	81,1	1827
ZSR2006216	62	16	128	124	15	70	12	88,8	1929
ZSR2006316	63	16	130	126	15	70	12	92,6	1969
ZSR2006416	64	16	132	128	15	70	12	95,1	2028
ZSR2006516	65	16	134	130	20	70	15	97,2	2194
ZSR2006716	67	16	138	134	20	70	15	101,6	2306
ZSR2006816	68	16	140	136	20	70	15	103,8	2360
ZSR2007016	70	16	144	140	20	70	15	108,2	2463
ZSR2007216	72	16	148	144	20	80	15	112,7	2769
ZSR2007416	74	16	152	148	20	80	15	136,5	2883
ZSR2007516	75	16	154	150	20	80	15	138,1	2945
ZSR2007616	76	16	156	152	20	80	15	139,7	2982
ZSR2007816	78	16	160	156	20	80	15	142,8	3129
ZSR2008016	80	16	164	160	20	80	20	146	3196
ZSR2008516	85	16	174	170	20	80	20	149	3513
ZSR2009016	90	16	184	180	20	80	20	150	3875
ZSR2009516	95	16	194	190	20	100	20	151	4652
ZSR2010016	100	16	204	200	20	100	20	154,3	5056
ZSR2011016	110	16	224	220	20	100	20	167,8	5856
ZSR2011416	114	16	232	228	20	100	20	173	6179
ZSR2012016	120	16	244	240	20	100	20	181	6822

Tab. 69

Modul 2,0 – Zahnbreite: 16 mm ohne Nabe

Artikel-Nr. ohne Nabe	Zähne- zahl	b mm	da mm	d mm	BH7 mm	zul. MD Nm	Gewicht g
ZSS2001816	18	16	40	36	12	1,5	108
ZSS2002016	20	16	44	40	12	1,9	138
ZSS2002116	21	16	46	42	12	2,1	154
ZSS2002216	22	16	48	44	12	2,3	170
ZSS2002316	23	16	50	46	12	2,6	187
ZSS2002416	24	16	52	48	12	2,9	206
ZSS2002516	25	16	54	50	12	3,2	225
ZSS2002616	26	16	56	52	12	3,5	244
ZSS2002716	27	16	58	54	12	3,8	265
ZSS2002816	28	16	60	56	12	4,1	286
ZSS2003016	30	16	64	60	12	4,8	330
ZSS2003216	32	16	68	64	12	5,6	380
ZSS2003516	35	16	74	70	12	6,9	457
ZSS2003616	36	16	76	72	12	7,3	486
ZSS2003716	37	16	78	74	12	7,8	514
ZSS2003816	38	16	80	76	12	24,1	545
ZSS2003916	39	16	82	78	12	25,6	578
ZSS2004016	40	16	84	80	12	27,1	605
ZSS2004116	41	16	86	82	12	28,7	639
ZSS2004216	42	16	88	84	12	30,4	668
ZSS2004316	43	16	90	86	12	32,1	703
ZSS2004516	45	16	94	90	12	35,6	773
ZSS2004715	47	16	98	94	12	39,8	843
ZSS2004816	48	16	100	96	12	42,5	879
ZSS2004916	49	16	102	98	12	45,2	921
ZSS2005016	50	16	104	100	12	48	954
ZSS2005116	51	16	106	102	12	50,9	995
ZSS2005216	52	16	108	104	12	54	1038
ZSS2005316	53	16	110	106	12	57,1	1092
ZSS2005416	54	16	112	108	12	60,3	1124
ZSS2005516	55	16	114	110	12	63,6	1153
ZSS2005616	56	16	116	112	12	67,1	1208
ZSS2005716	57	16	118	114	12	70,6	1249
ZSS2006016	60	16	124	120	12	81,1	1385
ZSS2006116	61	16	126	122	12	85,1	1443
ZSS2006316	63	16	130	126	12	92,6	1530
ZSS2006416	64	16	132	128	15	95,1	1576
ZSS2006516	65	16	134	130	15	97,2	1625
ZSS2006716	67	16	138	134	15	101,6	1733
ZSS2007016	70	16	144	140	15	108,2	1886
ZSS2007216	72	16	148	144	15	112,7	1988
ZSS2007516	75	16	154	150	15	138,1	2178
ZSS2007616	76	16	156	152	15	139,7	2229
ZSS2007816	78	16	160	156	15	142,8	2358
ZSS2008016	80	16	164	160	20	146	2458
ZSS2008516	85	16	174	170	20	149	2782
ZSS2009016	90	16	184	180	20	150	3134
ZSS2009516	95	16	194	190	20	151	3493
ZSS2009616	96	16	196	192	20	152	3556
ZSS2010016	100	16	204	200	20	154,3	3870
ZSS2011416	114	16	232	228	20	173	5052
ZSS2012016	120	16	244	240	20	181	5585

Tab. 70

Stahl

Modul 2,0:
Werkstoff: C45
gefräste Zähne
Verzahnungsqualität 8d25
DIN 3967
geradeverzahnt
Eingriffswinkel 20°

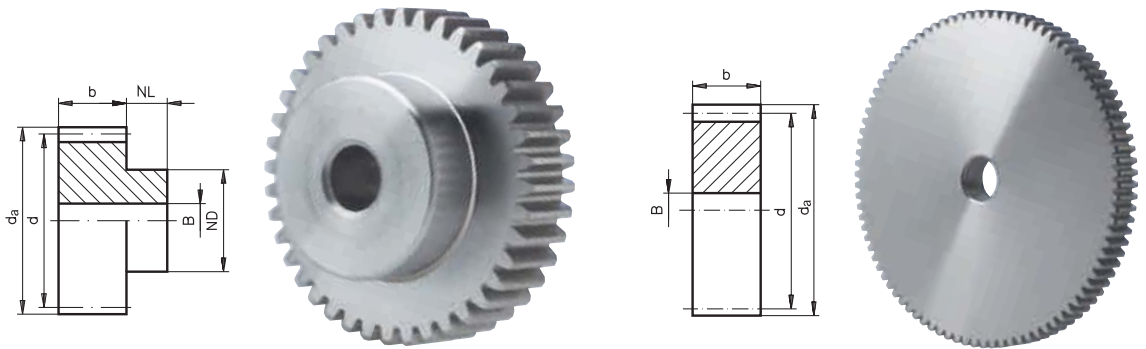

Modul 2,0 – Zahnbreite: 20 mm mit Nabe

Artikel-Nr. mit Nabe	Zähnezahl	b mm	da mm	d mm	NL mm	ND mm	BH7 mm	zul. MD Nm	Gewicht g
ZSR2001220	12	20	28	24	15	18	10	2,8	80
ZSR2001320	13	20	30	26	15	20	10	3,2	100
ZSR2001420	14	20	32	28	15	22	10	3,6	120
ZSR2001520	15	20	34	30	15	24	10	3,9	140
ZSR2001620	16	20	36	32	15	25	10	4,2	160
ZSR2001720	17	20	38	34	15	25	10	4,4	180
ZSR2001820	18	20	40	36	15	25	10	4,9	190
ZSR2001920	19	20	42	38	15	25	10	5,7	210
ZSR2002020	20	20	44	40	15	30	10	6,4	260
ZSR2002120	21	20	46	42	15	30	12	7,2	270
ZSR2002220	22	20	48	44	15	30	12	8	290
ZSR2002320	23	20	50	46	15	30	12	8,9	310
ZSR2002420	24	20	52	48	15	35	12	9,9	360
ZSR2002520	25	20	54	50	15	35	12	10,8	390
ZSR2002620	26	20	56	52	15	40	12	11,9	450
ZSR2002720	27	20	58	54	15	40	12	13	470
ZSR2002820	28	20	60	56	15	40	12	14,1	500
ZSR2002920	29	20	62	58	15	40	14	15,5	520
ZSR2003020	30	20	64	60	15	40	14	16,6	550
ZSR2003120	31	20	66	62	15	45	14	17,8	610
ZSR2003220	32	20	68	64	15	45	14	19,3	650
ZSR2003320	33	20	70	66	15	45	14	20,8	680
ZSR2003420	34	20	72	68	15	45	14	22,2	710
ZSR2003520	35	20	74	70	15	45	14	23,8	740
ZSR2003620	36	20	76	72	15	45	14	25,3	780
ZSR2003720	37	20	78	74	15	50	14	26,1	860
ZSR2003820	38	20	80	76	15	50	14	28,9	900
ZSR2003920	39	20	82	78	15	50	14	30,6	930
ZSR2004020	40	20	84	80	15	50	14	32,5	970
ZSR2004120	41	20	86	82	15	55	16	34,6	1050
ZSR2004220	42	20	88	84	15	55	16	36,5	1090
ZSR2004320	43	20	90	86	15	55	16	38,6	1130
ZSR2004420	44	20	92	88	15	60	16	40,6	1230
ZSR2004520	45	20	94	90	15	60	16	42,7	1270
ZSR2004620	46	20	96	92	15	60	16	45	1310
ZSR2004720	47	20	98	94	15	70	16	47,8	1480
ZSR2004820	48	20	100	96	15	70	16	51	1530
ZSR2004920	49	20	102	98	15	70	16	54,2	1570
ZSR2005020	50	20	104	100	15	70	16	57,6	1620
ZSR2005120	51	20	106	102	15	70	16	61,1	1670
ZSR2005220	52	20	108	104	15	70	16	64,8	1720
ZSR2005320	53	20	110	106	15	70	16	68,5	1780
ZSR2005420	54	20	112	108	15	70	16	72,4	1830
ZSR2005520	55	20	114	110	15	70	16	76,3	1880
ZSR2005620	56	20	116	112	15	70	16	80,5	1940
ZSR2005720	57	20	118	114	15	70	16	84,7	1990
ZSR2005820	58	20	120	116	15	70	16	89	2050
ZSR2005920	59	20	122	118	15	70	16	93,1	2110
ZSR2006020	60	20	124	120	15	70	16	97,3	2160
ZSR2006120	61	20	126	122	15	80	16	102	2360
ZSR2006220	62	20	128	124	15	80	16	107	2420
ZSR2006320	63	20	130	126	15	80	16	111	2480
ZSR2006420	64	20	132	128	15	80	16	114	2550
ZSR2006520	65	20	134	130	15	80	16	117	2610
ZSR2006620	66	20	136	132	15	80	16	120	2670
ZSR2006720	67	20	138	134	15	80	16	122	2740
ZSR2006820	68	20	140	136	15	80	16	125	2810
ZSR2006920	69	20	142	138	15	80	16	127	2870
ZSR2007020	70	20	144	140	15	80	16	130	2940
ZSR2007520	75	20	154	150	15	80	20	166	3250
ZSR2008020	80	20	164	160	15	80	20	175	3600
ZSR2009020	90	20	184	180	15	90	20	180	4570
ZSR2010020	100	20	204	200	15	100	20	185	5670
ZSR2012020	120	20	244	240	15	100	20	217	7790

Tab. 71

Modul 2,0 – Zahnbreite: 20 mm ohne Nabe

Artikel-Nr. ohne Nabe	Zähnezahl	b mm	da mm	d mm	BH7 mm	zul. MD Nm	Gewicht g
ZSS2001820	18	20	40	36	10	4,9	145
ZSS2002020	20	20	44	40	10	6,4	180
ZSS2002420	24	20	52	48	12	9,9	260
ZSS2002520	25	20	54	50	12	10,8	285
ZSS2003020	30	20	64	60	14	16,6	410
ZSS2003520	35	20	74	70	14	23,8	570
ZSS2003620	36	20	76	72	14	25,3	600
ZSS2004020	40	20	84	80	14	32,5	750
ZSS2004520	45	20	94	90	16	42,7	950
ZSS2004820	48	20	100	96	16	51	1080
ZSS2005020	50	20	104	100	16	57,6	1180
ZSS2007220	72	20	148	144	16	135	2500
ZSS2007520	75	20	154	150	20	166	2710
ZSS2007620	76	20	156	152	20	168	2790
ZSS2008020	80	20	164	160	20	175	3090
ZSS2008520	85	20	174	170	20	179	3500
ZSS2009020	90	20	184	180	20	180	3930
ZSS2009520	95	20	194	190	20	181	4390
ZSS2010020	100	20	204	200	20	185	4870
ZSS2011020	110	20	224	220	20	201	5900
ZSS2011420	114	20	232	228	20	208	6340
ZSS2012020	120	20	244	240	20	217	7030
ZSS2012720	127	20	258	254	20	235	7890

Tab. 72

Stahl

Modul 2,5:

Werkstoff: C45
gefräste Zähne
Verzahnungsqualität 8d25
DIN 3967
geradeverzahnt
Eingriffswinkel 20°

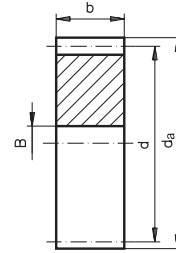
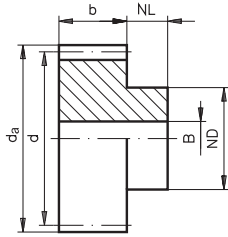

Modul 2,5 – Zahnbreite: 20 mm mit Nabe

Artikel-Nr. mit Nabe	Zähne- zahl	b mm	da mm	d mm	NL mm	ND mm	BH7 mm	zul. MD Nm	Gewicht kg
ZSR2501220	12	20	35	30	15	20	12	4,9	0,11
ZSR2501320	13	20	37,5	32,5	15	20	12	5,6	0,12
ZSR2501420	14	20	40	35	15	20	12	6,3	0,14
ZSR2501520	15	20	42,5	37,5	15	25	12	6,9	0,19
ZSR2501620	16	20	45	40	15	25	12	7,4	0,21
ZSR2501720	17	20	47,5	42,5	15	25	12	7,7	0,23
ZSR2501820	18	20	50	45	15	30	12	8,7	0,29
ZSR2501920	19	20	52,5	47,5	15	30	12	9,9	0,31
ZSR2502020	20	20	55	50	15	30	12	11,2	0,34
ZSR2502120	21	20	57,5	52,5	15	30	12	12,6	0,38
ZSR2502220	22	20	60	55	15	30	12	14,1	0,41
ZSR2502320	23	20	62,5	57,5	15	40	12	15,6	0,51
ZSR2502420	24	20	65	60	15	40	12	17,3	0,54
ZSR2502520	25	20	67,5	62,5	15	40	12	19	0,58
ZSR2502620	26	20	70	65	15	40	12	20,8	0,62
ZSR2502720	27	20	72,5	67,5	15	40	12	22,7	0,66
ZSR2502820	28	20	75	70	15	40	12	24,7	0,7
ZSR2503020	30	20	80	75	15	40	12	29,1	0,79
ZSR2503220	32	20	85	80	15	50	15	33,8	0,95
ZSR2503420	34	20	90	85	15	50	15	38,9	1,04
ZSR2503520	35	20	92,5	87,5	15	50	15	41,6	1,1
ZSR2503620	36	20	95	90	15	60	15	44,4	1,25
ZSR2503820	38	20	100	95	15	60	15	50,7	1,38
ZSR2504020	40	20	105	100	20	60	15	59,3	1,6
ZSR2504220	42	20	110	105	20	60	15	68,5	1,72
ZSR2504520	45	20	117,5	112,5	20	60	15	83,9	1,92
ZSR2504620	46	20	120	115	20	60	15	89,4	1,98
ZSR2504820	48	20	125	120	20	60	15	100,3	2,14
ZSR2505020	50	20	130	125	20	70	15	112,2	2,43
ZSR2505220	52	20	135	130	20	70	15	124,3	2,6
ZSR2505420	54	20	140	135	20	70	20	137,2	2,73
ZSR2505520	55	20	142,5	137,5	20	70	20	143,9	2,78
ZSR2505620	56	20	145	140	20	70	20	150,9	2,89
ZSR2506020	60	20	155	150	20	70	20	180,9	3,24
ZSR2506220	62	20	160	155	20	70	20	197,3	3,43
ZSR2506520	65	20	167,5	162,5	20	80	20	238,3	3,9
ZSR2507020	70	20	180	175	20	80	20	269,6	4,44
ZSR2507220	72	20	185	180	20	80	20	276,3	4,62
ZSR2507520	75	20	192,5	187,5	20	90	20	282	5,19
ZSR2508020	80	20	205	200	20	90	20	285	5,79
ZSR2508220	82	20	210	205	20	90	20	286	6,05
ZSR2508520	85	20	217,5	212,5	20	100	20	288	6,69
ZSR2509020	90	20	230	225	20	100	20	290	7,31
ZSR2509220	92	20	235	230	20	100	20	292	7,6
ZSR2509520	95	20	242,5	237,5	20	100	25	301	7,97
ZSR2510020	100*	20	255	250	20	100	25	315	8,74
ZSR2511020	110*	20	280	275	20	120	25	340	10,86
ZSR2511420	114*	20	290	285	20	120	25	349	11,61
ZSR2512020	120*	20	305	300	20	120	25	365	12,64
ZSR2512720	127*	20	322,5	317,5	20	120	25	380	13,96

* Diese Räder haben angeschweißte Naben.

Tab.73

Modul 2,5 – Zahnbreite: 20 mm ohne Nabe

Artikel-Nr. ohne Nabe	Zähne- zahl	b mm	da mm	d mm	BH7 mm	zul. MD Nm	Gewicht kg
ZSS2501820	18	20	50	45	12	8,7	0,23
ZSS2502020	20	20	55	50	12	11,2	0,29
ZSS2502220	22	20	60	55	12	14,1	0,34
ZSS2502320	23	20	62,5	57,5	12	15,6	0,37
ZSS2502420	24	20	65	60	12	17,3	0,41
ZSS2502520	25	20	67,5	62,5	12	19	0,45
ZSS2502620	26	20	70	65	12	20,8	0,49
ZSS2502920	29	20	77,5	72,5	12	26	0,61
ZSS2503020	30	20	80	75	12	29,1	0,66
ZSS2503120	31	20	82,5	77,5	12	31,4	0,7
ZSS2503320	33	20	87,5	82,5	15	36,3	0,79
ZSS2503420	34	20	90	85	15	38,9	0,84
ZSS2503520	35	20	92,5	87,5	15	41,6	0,89
ZSS2503720	37	20	97,5	92,5	15	47,3	1
ZSS2503820	38	20	100	95	15	50,7	1,06
ZSS2503920	39	20	102,5	97,5	15	54,9	1,12
ZSS2504020	40	20	105	100	15	59,3	1,18
ZSS2504120	41	20	107,5	102,5	15	65,8	1,24
ZSS2504320	43	20	112,5	107,5	15	73,5	1,38
ZSS2504420	44	20	115	110	15	78,6	1,43
ZSS2504520	45	20	117,5	112,5	15	83,9	1,5
ZSS2504720	47	20	122,5	117,5	15	95	1,64
ZSS2504820	48	20	125	120	15	100,3	1,71
ZSS2504920	49	20	127,5	122,5	15	106,5	1,79
ZSS2505020	50	20	130	125	15	112,1	1,86
ZSS2505120	51	20	132,5	127,5	15	118,2	1,94
ZSS2505320	53	20	137,5	132,5	15	130,6	2,1
ZSS2505420	54	20	140	135	20	137,2	2,17
ZSS2505520	55	20	142,5	137,5	20	143,9	2,25
ZSS2505620	56	20	145	140	20	150,9	2,33
ZSS2505720	57	20	147,5	142,5	20	158,1	2,43
ZSS2506020	60	20	155	150	20	180,9	2,69
ZSS2507020	70	20	180	175	20	269,6	3,68
ZSS2507620	76	20	195	190	20	283,8	4,35
ZSS2508020	80	20	205	200	20	285	4,83
ZSS2509020	90	20	230	225	20	290	6,13
ZSS2510020	100	20	255	250	20	315	7,62
ZSS2511420	114	20	290	285	25	349	9,8
ZSS2512020	120	20	305	300	25	365	10,94

Tab.74

Stahl

Modul 2,5:
Werkstoff: C45
gefräste Zähne
Verzahnungsqualität 8d25
DIN 3967
geradeverzahnt
Eingriffswinkel 20°

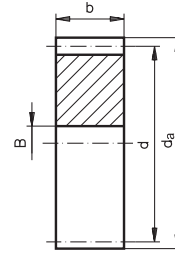
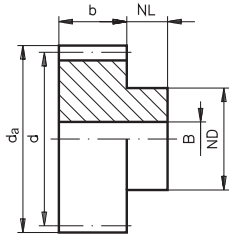

Modul 2,5 – Zahnbreite: 25 mm mit Nabe

Artikel-Nr. mit Nabe	Zähnezahl	b mm	da mm	d mm	NL mm	ND mm	B ^{H7} mm	zul. MD Nm	Gewicht kg
ZSR2501225	12	25	35	30	20	22	10	5,9	0,17
ZSR2501325	13	25	37,5	32,5	20	25	10	6,7	0,21
ZSR2501425	14	25	40	35	20	28	10	7,6	0,25
ZSR2501525	15	25	42,5	37,5	20	30	10	8,3	0,3
ZSR2501625	16	25	45	40	20	32	12	8,9	0,33
ZSR2501725	17	25	47,5	42,5	20	35	12	9,2	0,38
ZSR2501825	18	25	50	45	20	35	12	10,4	0,42
ZSR2501925	19	25	52,5	47,5	20	35	12	11,9	0,45
ZSR2502025	20	25	55	50	20	40	12	13,4	0,54
ZSR2502125	21	25	57,5	52,5	20	40	14	15,1	0,56
ZSR2502225	22	25	60	55	20	45	14	16,9	0,66
ZSR2502325	23	25	62,5	57,5	20	45	14	18,7	0,7
ZSR2502425	24	25	65	60	20	45	14	20,8	0,74
ZSR2502525	25	25	67,5	62,5	20	50	14	22,8	0,85
ZSR2502625	26	25	70	65	20	50	14	25	0,9
ZSR2502725	27	25	72,5	67,5	20	50	14	27,3	0,95
ZSR2502825	28	25	75	70	20	50	14	29,6	1
ZSR2502925	29	25	77,5	72,5	20	50	14	32,7	1,06
ZSR2503025	30	25	80	75	20	55	14	34,9	1,18
ZSR2503125	31	25	82,5	77,5	20	55	16	37,5	1,22
ZSR2503225	32	25	85	80	20	55	16	40,6	1,28
ZSR2503325	33	25	87,5	82,5	20	55	16	43,8	1,34
ZSR2503425	34	25	90	85	20	55	16	46,7	1,41
ZSR2503525	35	25	92,5	87,5	20	60	16	50,2	1,54
ZSR2503625	36	25	95	90	20	60	16	53,3	1,61
ZSR2503725	37	25	97,5	92,5	20	60	16	54,9	1,68
ZSR2503825	38	25	100	95	20	60	16	60,8	1,75
ZSR2503925	39	25	102,5	97,5	20	60	16	65,3	1,83
ZSR2504025	40	25	105	100	20	70	16	71,2	2,06
ZSR2504125	41	25	107,5	102,5	20	70	16	77,4	2,14
ZSR2504225	42	25	110	105	20	70	16	82,2	2,22
ZSR2504325	43	25	112,5	107,5	20	70	16	92,4	2,3
ZSR2504425	44	25	115	110	20	70	16	96,6	2,38
ZSR2504525	45	25	117,5	112,5	20	70	16	100	2,47
ZSR2504625	46	25	120	115	20	70	20	107	2,52
ZSR2504725	47	25	122,5	117,5	20	80	20	114	2,8
ZSR2504825	48	25	125	120	20	80	20	120	2,88
ZSR2504925	49	25	127,5	122,5	20	80	20	128	2,98
ZSR2505025	50	25	130	125	20	80	20	135	3,07
ZSR2505125	51	25	132,5	127,5	20	80	20	143	3,17
ZSR2505225	52	25	135	130	20	90	20	149	3,48
ZSR2505325	53	25	137,5	132,5	20	90	20	156	3,58
ZSR2505425	54	25	140	135	20	90	20	165	3,68
ZSR2505525	55	25	142,5	137,5	20	90	20	173	3,78
ZSR2505625	56	25	145	140	20	100	20	181	4,13
ZSR2505725	57	25	147,5	142,5	20	100	20	190	4,23
ZSR2505825	58	25	150	145	20	100	20	199	4,34
ZSR2505925	59	25	152,5	147,5	20	100	20	208	4,46
ZSR2506025	60	25	155	150	20	100	20	217	4,57
ZSR2507025	70	25	180	175	20	100	20	324	5,74
ZSR2509025	90	25	230	225	20	120	25	348	9,24
ZSR2512025	120	25	305	300	20	120	25	438	15,19

Tab. 75

Modul 2,5 – Zahnbreite: 25 mm ohne Nabe

Artikel-Nr. ohne Nabe	Zähnezahl	b mm	da mm	d mm	B ^{H7} mm	zul. MD Nm	Gewicht kg
ZSS2501825	18	25	50	45	12	10,4	0,28
ZSS2502025	20	25	55	50	12	13,4	0,36
ZSS2502225	22	25	60	55	14	16,9	0,43
ZSS2502425	24	25	65	60	14	20,8	0,51
ZSS2502525	25	25	67,5	62,5	14	22,8	0,56
ZSS2503025	30	25	80	75	14	34,9	0,82
ZSS2504025	40	25	105	100	16	71,2	1,47
ZSS2504825	48	25	125	120	20	120	2,12
ZSS2505025	50	25	130	125	20	135	2,3
ZSS2506025	60	25	155	150	20	217	3,34
ZSS2506525	65	25	167,5	162,5	20	286	3,99
ZSS2507025	70	25	180	175	20	324	4,64
ZSS2507225	72	25	185	180	20	332	4,91
ZSS2507525	75	25	192,5	187,5	20	338	5,33
ZSS2507625	76	25	195	190	20	340	5,48
ZSS2508025	80	25	205	200	25	342	6,04
ZSS2508525	85	25	217,5	212,5	25	346	6,84
ZSS2509025	90	25	230	225	25	348	7,68
ZSS2509525	95	25	242,5	237,5	25	361	8,57
ZSS2510025	100	25	255	250	25	378	9,51
ZSS2511025	110	25	280	275	25	408	11,53
ZSS2511425	114	25	290	285	25	419	12,39
ZSS2512025	120	25	305	300	25	438	13,74
ZSS2512725	127	25	322,5	317,5	25	453	15,4

Tab. 76

Stahl

Modul 3,0:

Werkstoff: C45
gefräste Zähne
Verzahnungsqualität 8d25
DIN 3967
geradeverzahnt
Eingriffswinkel 20°

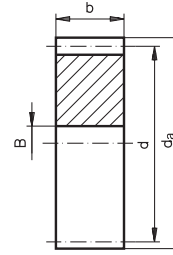
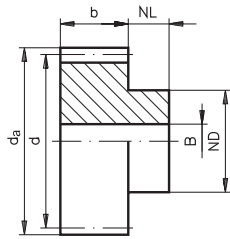

Modul 3,0 – Zahnbreite: 25 mm mit Nabe

Artikel-Nr. mit Nabe	Zähne- zahl	b mm	d _a mm	d mm	NL mm	ND mm	BH7 mm	zul. MD Nm	Gewicht kg
ZSR3001225	12	25	42	36	15	25	12	9,3	0,21
ZSR3001325	13	25	45	39	15	25	12	10,5	0,24
ZSR3001425	14	25	48	42	15	25	12	11,8	0,28
ZSR3001525	15	25	51	45	15	35	12	13	0,37
ZSR3001625	16	25	54	48	15	35	12	14	0,41
ZSR3001725	17	25	57	51	15	35	12	14,8	0,46
ZSR3001825	18	25	60	54	15	45	12	16,5	0,58
ZSR3001925	19	25	63	57	15	45	12	18,8	0,63
ZSR3002025	20	25	66	60	15	45	15	21,3	0,67
ZSR3002125	21	25	69	63	15	45	15	23,9	0,72
ZSR3002225	22	25	72	66	15	45	15	26,7	0,78
ZSR3002325	23	25	75	69	15	50	15	29,6	0,89
ZSR3002425	24	25	78	72	15	50	15	32,7	0,95
ZSR3002525	25	25	81	75	15	50	15	36	1,01
ZSR3002625	26	25	84	78	15	50	15	39,5	1,08
ZSR3002725	27	25	87	81	15	50	15	43,2	1,16
ZSR3002825	28	25	90	84	15	50	20	47	1,19
ZSR3003025	30	25	96	90	15	50	20	55,2	1,35
ZSR3003225	32	25	102	96	15	60	20	64,9	1,62
ZSR3003525	35	25	111	105	15	60	20	85	1,9
ZSR3003625	36	25	114	108	15	60	20	92,4	2
ZSR3003825	38	25	120	114	20	60	20	108,2	2,3
ZSR3004025	40	25	126	120	20	70	20	124,7	2,67
ZSR3004225	42	25	132	126	20	70	20	142,3	2,89
ZSR3004525	45	25	141	135	20	70	20	170,2	3,26
ZSR3004825	48	25	150	144	20	80	20	201,5	3,84
ZSR3005025	50	25	156	150	20	80	20	224,3	4,1
ZSR3005225	52	25	162	156	20	80	20	248,6	4,39
ZSR3005425	54	25	168	162	20	80	20	274,6	4,66
ZSR3005525	55	25	171	165	20	80	20	288,2	4,82
ZSR3005625	56	25	174	168	20	90	20	302,2	5,18
ZSR3005725	57	25	177	171	20	90	20	316,7	5,33
ZSR3005825	58	25	180	174	20	90	20	331,5	5,49
ZSR3006025	60	25	186	180	20	90	20	380,3	5,83
ZSR3006525	65	25	201	195	20	90	20	461,9	6,67
ZSR3006725	67	25	207	201	20	90	20	476,4	7,04
ZSR3007025	70	25	216	210	20	90	20	480	7,64
ZSR3007225	72	25	222	216	20	100	20	482	8,22
ZSR3007525	75	25	231	225	20	100	20	484	8,87
ZSR3007625	76	25	234	228	20	100	30	486	8,94
ZSR3008025	80	25	246	240	20	100	30	490	9,77
ZSR3009025	90*	25	276	270	20	100	30	530,4	12,12
ZSR3010025	100*	25	306	300	20	100	30	580	14,72
ZSR3011425	114*	25	348	342	20	100	30	644	18,79
ZSR3012025	120*	25	366	360	20	100	30	673	21

* Diese Räder haben angeschweißte Naben.

Tab.77

Modul 3,0 – Zahnbreite: 25 mm ohne Nabe

Artikel-Nr. ohne Nabe	Zähne- zahl	b mm	d _a mm	d mm	BH7 mm	zul. MD Nm	Gewicht kg
ZSS3001825	18	25	60	54	12	16,5	0,42
ZSS3002025	20	25	66	60	15	21,3	0,5
ZSS3002125	21	25	69	63	15	23,9	0,55
ZSS3002425	24	25	78	72	15	32,7	0,74
ZSS3002525	25	25	81	75	15	36	0,81
ZSS3002825	28	25	90	84	15	47	1,02
ZSS3003025	30	25	96	90	20	55,2	1,15
ZSS3003525	35	25	111	105	20	85	1,61
ZSS3003725	37	25	117	111	20	100,2	1,8
ZSS3003825	38	25	120	114	20	108	1,91
ZSS3004025	40	25	126	120	20	125	2,11
ZSS3004225	42	25	132	126	20	142	2,34
ZSS3004525	45	25	141	135	20	170	2,7
ZSS3004625	46	25	144	138	20	180	2,81
ZSS3004725	47	25	147	141	20	191	2,95
ZSS3004825	48	25	150	144	20	202	3,09
ZSS3005025	50	25	156	150	20	224	3,34
ZSS3005225	52	25	162	156	20	249	3,64
ZSS3005325	53	25	165	159	20	261	3,78
ZSS3005625	56	25	174	168	20	302	4,23
ZSS3005825	58	25	180	174	20	332	4,54
ZSS3006025	60	25	186	180	20	380	4,87
ZSS3006525	65	25	201	195	20	462	5,72
ZSS3006725	67	25	207	201	20	476	6,09
ZSS3007025	70	25	216	210	20	480	6,67
ZSS3007225	72	25	222	216	30	482	6,99
ZSS3007625	76	25	234	228	30	486	7,8
ZSS3008025	80	25	246	240	30	490	8,63
ZSS3009025	90	25	276	270	30	530	11
ZSS3009625	96	25	294	288	30	559	12,53
ZSS3010025	100	25	306	300	30	580	13,61
ZSS3011425	114	25	348	342	30	644	17,72

Tab.78

Stahl

Modul 3,0:
Werkstoff: C45
gefräste Zähne
Verzahnungsqualität 8d25
DIN 3967
geradeverzahnt
Eingriffswinkel 20°

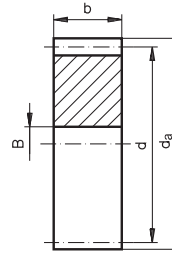
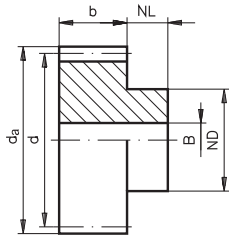

Modul 3,0 – Zahnbreite: 30 mm mit Nabe

Artikel-Nr. mit Nabe	Zähnezahl	b mm	da mm	d mm	NL mm	ND mm	BH7 mm	zul. MD Nm	Gewicht kg
ZSR3001230	12	30	42	36	20	27	12	10,7	0,28
ZSR3001330	13	30	45	39	20	30	12	12,1	0,34
ZSR3001430	14	30	48	42	20	33	12	13,6	0,41
ZSR3001530	15	30	51	45	20	35	12	15	0,47
ZSR3001630	16	30	54	48	20	38	14	16,1	0,54
ZSR3001730	17	30	57	51	20	42	14	17	0,63
ZSR3001830	18	30	60	54	20	45	14	19	0,72
ZSR3001930	19	30	63	57	20	45	14	21,6	0,78
ZSR3002030	20	30	66	60	20	45	14	24,5	0,84
ZSR3002130	21	30	69	63	20	45	16	27,5	0,89
ZSR3002230	22	30	72	66	20	50	16	30,7	1,02
ZSR3002330	23	30	75	69	20	50	16	34	1,1
ZSR3002430	24	30	78	72	20	50	16	37,6	1,18
ZSR3002530	25	30	81	75	20	60	16	41,4	1,39
ZSR3002630	26	30	84	78	20	60	16	45,4	1,48
ZSR3002730	27	30	87	81	20	60	16	49,7	1,56
ZSR3002830	28	30	90	84	20	60	16	54,1	1,66
ZSR3002930	29	30	93	87	20	60	16	59,2	1,75
ZSR3003030	30	30	96	90	20	60	16	63,5	1,85
ZSR3003130	31	30	99	93	20	60	16	69,2	1,95
ZSR3003230	32	30	102	96	20	70	16	74,6	2,21
ZSR3003330	33	30	105	99	20	70	16	82,8	2,32
ZSR3003430	34	30	108	102	20	70	16	88,6	2,43
ZSR3003530	35	30	111	105	20	70	16	97,8	2,55
ZSR3003630	36	30	114	108	20	70	20	106	2,62
ZSR3003730	37	30	117	111	20	70	20	115	2,74
ZSR3003830	38	30	120	114	20	80	20	124	3,05
ZSR3003930	39	30	123	117	20	80	20	135	3,18
ZSR3004030	40	30	126	120	20	80	20	143	3,31
ZSR3004130	41	30	129	123	20	80	20	155	3,44
ZSR3004230	42	30	132	126	20	80	20	164	3,58
ZSR3004330	43	30	135	129	20	80	20	175	3,72
ZSR3004430	44	30	138	132	20	90	20	186	4,07
ZSR3004530	45	30	141	135	20	90	20	196	4,22
ZSR3004630	46	30	144	138	20	90	20	207	4,37
ZSR3004730	47	30	147	141	20	100	20	220	4,76
ZSR3004830	48	30	150	144	20	100	20	232	4,92
ZSR3005030	50	30	156	150	20	100	20	258	5,18
ZSR3006030	60	30	186	180	20	100	20	437	6,97
ZSR3006530	65	30	201	195	20	100	20	531	7,99
ZSR3007030	70	30	216	210	20	100	25	552	9,03
ZSR3007530	75	30	231	225	20	120	25	557	10,75
ZSR3009030	90	30	276	270	20	120	25	610	14,79
ZSR3012030	120	30	366	360	20	120	30	774	24,98

Tab.79

Modul 3,0 – Zahnbreite: 30 mm ohne Nabe

Artikel-Nr. ohne Nabe	Zähnezahl	b mm	da mm	d mm	BH7 mm	zul. MD Nm	Gewicht kg
ZSS3001830	18	30	60	54	14	19	0,49
ZSS3002030	20	30	66	60	14	24,5	0,68
ZSS3002430	24	30	78	72	16	37,6	0,89
ZSS3002530	25	30	81	75	16	41,4	0,97
ZSS3003030	30	30	96	90	16	63,5	1,42
ZSS3004030	40	30	126	120	20	143	2,54
ZSS3004830	48	30	150	144	20	232	3,69
ZSS3005030	50	30	156	150	20	258	4,06
ZSS3005230	52	30	162	156	20	286	4,4
ZSS3005530	55	30	171	165	20	331	4,93
ZSS3005730	57	30	177	171	20	364	5,3
ZSS3006030	60	30	186	180	20	437	5,89
ZSS3006530	65	30	201	195	20	531	6,92
ZSS3007030	70	30	216	210	25	552	8
ZSS3007230	72	30	222	216	25	554	8,47
ZSS3007530	75	30	231	225	25	557	9,21
ZSS3007630	76	30	234	228	25	559	9,46
ZSS3008030	80	30	246	240	25	564	10,49
ZSS3008530	85	30	261	255	25	580	11,86
ZSS3009030	90	30	276	270	25	610	13,32
ZSS3009530	95	30	291	285	25	640	14,86
ZSS3010030	100	30	306	300	25	667	16,48
ZSS3011030	110	30	336	330	25	705	19,97
ZSS3011430	114	30	348	342	30	740	21,4
ZSS3012030	120	30	366	360	30	774	23,74
ZSS3012730	127	30	387	381	30	800	26,61

Tab.80

Stahl

Modul 4,0:

Werkstoff: C45
gefräste Zähne
Verzahnungsqualität 8d25
DIN 3967
geradeverzahnt
Eingriffswinkel 20°

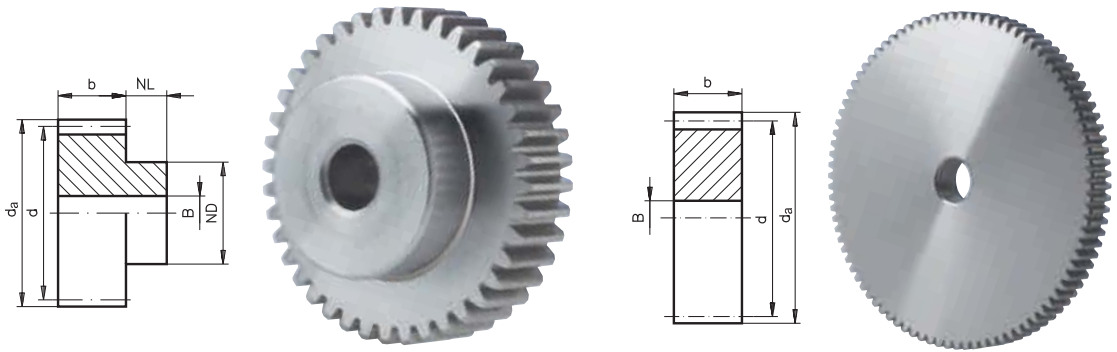

Modul 4,0 – Zahnbreite: 30 mm mit Nabe

Artikel-Nr. mit Nabe	Zähne- zahl	b mm	da mm	d mm	NL mm	ND mm	BH7 mm	zul. MD Nm	Gewicht kg
ZSR4001230	12	30	56	48	20	35	15	21	0,48
ZSR4001330	13	30	60	52	20	35	15	24	0,55
ZSR4001430	14	30	64	56	20	40	15	27	0,68
ZSR4001530	15	30	68	60	20	40	15	30	0,76
ZSR4001630	16	30	72	64	20	40	20	32	0,8
ZSR4001730	17	30	76	68	20	40	20	34	0,9
ZSR4001830	18	30	80	72	20	50	20	38	1,11
ZSR4001930	19	30	84	76	20	50	20	43	1,21
ZSR4002030	20	30	88	80	20	50	20	49	1,33
ZSR4002130	21	30	92	84	20	50	20	55	1,45
ZSR4002230	22	30	96	88	20	50	20	62	1,58
ZSR4002330	23	30	100	92	20	50	20	69	1,7
ZSR4002430	24	30	104	96	20	60	20	76	1,98
ZSR4002530	25	30	108	100	20	60	20	87	2,12
ZSR4002630	26	30	112	104	20	60	20	97	2,28
ZSR4002730	27	30	116	108	20	60	20	109	2,43
ZSR4002830	28	30	120	112	20	60	20	122	2,58
ZSR4003030	30	30	128	120	20	70	20	148	3,08
ZSR4003230	32	30	136	128	20	70	20	176	3,44
ZSR4003530	35	30	148	140	20	70	25	222	3,97
ZSR4003630	36	30	152	144	20	70	25	239	4,18
ZSR4003830	38	30	160	152	20	70	25	275	4,61
ZSR4004030	40	30	168	160	20	80	25	315	5,27
ZSR4004230	42	30	176	168	20	80	25	358	5,77
ZSR4004430	44	30	184	176	20	80	25	404	6,24
ZSR4004530	45	30	188	180	20	80	25	429	6,52
ZSR4004630	46	30	192	184	20	80	25	456	6,79
ZSR4004830	48	30	200	192	20	100	25	510	7,78
ZSR4005030	50	30	208	200	20	100	25	568	8,36
ZSR4005230	52	30	216	208	20	100	25	636	8,96
ZSR4005430	54	30	224	216	20	100	25	698	9,5
ZSR4005530	55	30	228	220	20	100	25	730	10
ZSR4005630	56	30	232	224	20	100	25	763	10,5
ZSR4005830	58	30	240	232	20	100	25	832	11
ZSR4006030	60	30	248	240	20	100	25	905	11,5
ZSR4006530	65*	30	268	260	20	100	30	976	13,5
ZSR4006730	67*	30	276	268	20	100	30	980	14
ZSR4007030	70*	30	288	280	20	100	30	985	15,3
ZSR4007230	72*	30	296	288	20	100	30	993	16
ZSR4007530	75*	30	308	300	20	100	30	1030	17,5
ZSR4007630	76*	30	312	304	20	120	30	1042	18,38
ZSR4008030	80*	30	328	320	20	120	30	1083	20
ZSR4009030	90*	30	368	360	20	120	30	1200	25,2
ZSR4009630	96*	30	392	384	20	120	30	1270	28,5
ZSR4010030	100*	30	408	400	20	120	30	1320	31

Tab.81

Modul 4,0 – Zahnbreite: 30 mm ohne Nabe

Artikel-Nr. ohne Nabe	Zähne- zahl	b mm	da mm	d mm	BH7 mm	zul. MD Nm	Gewicht kg
ZSS4002030	20	30	88	80	20	49	1,07
ZSS4002430	24	30	104	96	20	76	1,59
ZSS4002530	25	30	108	100	20	87	1,73
ZSS4003030	30	30	128	120	25	148	2,49
ZSS4003530	35	30	148	140	25	222	3,44
ZSS4003630	36	30	152	144	25	239	3,55
ZSS4003730	37	30	156	148	25	256	3,86
ZSS4003830	38	30	160	152	25	275	4,04
ZSS4004030	40	30	168	160	25	315	4,55
ZSS4004230	42	30	176	168	25	358	5,02
ZSS4004530	45	30	188	180	25	429	5,78
ZSS4004630	46	30	192	184	25	456	6,08
ZSS4004730	47	30	196	188	25	483	6,34
ZSS4004830	48	30	200	192	25	510	6,62
ZSS4005030	50	30	208	200	25	568	7,18
ZSS4005230	52	30	216	208	25	636	7,78
ZSS4005630	56	30	232	224	25	763	9,06
ZSS4006030	60	30	248	240	25	905	10,42
ZSS4006530	65	30	268	260	30	976	12,19
ZSS4006730	67	30	276	268	30	980	12,99
ZSS4007030	70	30	288	280	30	985	14,14
ZSS4007630	76	30	312	304	30	1042	17
ZSS4008030	80	30	328	320	30	1083	18,5
ZSS4009030	90	30	368	360	30	1200	23,5
ZSS4009630	96	30	392	384	30	1270	26,89

Tab.82

* Diese Räder haben angeschweißte Naben.

Stahl

Modul 4,0:
Werkstoff: C45
gefräste Zähne
Verzahnungsqualität 8d25
DIN 3967
geradeverzahnt
Eingriffswinkel 20°

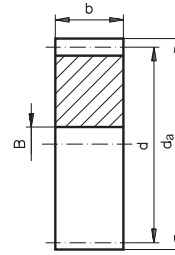
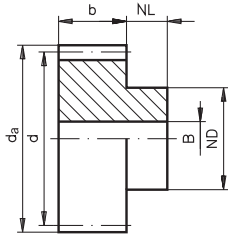

Modul 4,0 – Zahnbreite: 40 mm mit Nabe

Artikel-Nr. mit Nabe	Zähnezahl	b mm	d _a mm	d mm	NL mm	ND mm	BH ⁷ mm	zul. MD Nm	Gewicht kg
ZSR4001240	12	40	56	48	20	35	14	26	0,63
ZSR4001340	13	40	60	52	20	40	14	30	0,78
ZSR4001440	14	40	64	56	20	45	14	34	0,93
ZSR4001540	15	40	68	60	20	45	14	38	1,05
ZSR4001640	16	40	72	64	20	50	16	40	1,2
ZSR4001740	17	40	76	68	20	50	16	43	1,33
ZSR4001840	18	40	80	72	20	50	16	48	1,47
ZSR4001940	19	40	84	76	20	60	16	54	1,75
ZSR4002040	20	40	88	80	20	60	16	61	1,9
ZSR4002140	21	40	92	84	20	70	16	69	2,22
ZSR4002240	22	40	96	88	20	70	16	78	2,39
ZSR4002340	23	40	100	92	20	75	20	86	2,6
ZSR4002440	24	40	104	96	20	75	20	95	2,79
ZSR4002540	25	40	108	100	20	75	20	109	2,98
ZSR4002640	26	40	112	104	20	75	20	121	3,18
ZSR4002740	27	40	116	108	20	75	20	136	3,39
ZSR4002840	28	40	120	112	20	75	20	153	3,6
ZSR4002940	29	40	124	116	20	75	20	171	3,83
ZSR4003040	30	40	128	120	20	75	20	185	4,06
ZSR4003140	31	40	132	124	20	80	20	205	4,39
ZSR4003240	32	40	136	128	20	80	20	220	4,64
ZSR4003340	33	40	140	132	20	80	20	248	4,9
ZSR4003440	34	40	144	136	20	80	20	264	5,16
ZSR4003540	35	40	148	140	20	80	20	278	5,43
ZSR4003640	36	40	152	144	20	80	25	299	5,63
ZSR4003840	38	40	160	152	20	80	25	344	6,14
ZSR4004040	40	40	168	160	20	80	25	394	6,74
ZSR4005040	50	40	208	200	20	100	25	710	10,66
ZSR4006040	60	40	248	240	20	100	25	1131	14,92
ZSR4009040	90	40	368	360	20	120	30	1500	32,76

Tab.83

Modul 4,0 – Zahnbreite: 40 mm ohne Nabe

Artikel-Nr. ohne Nabe	Zähnezahl	b mm	d _a mm	d mm	BH ⁷ mm	zul. MD Nm	Gewicht kg
ZSS4002040	20	40	88	80	16	61	1,49
ZSS4002440	24	40	104	96	20	95	2,13
ZSS4002540	25	40	108	100	20	109	2,32
ZSS4003040	30	40	128	120	20	185	3,38
ZSS4003540	35	40	148	140	20	278	4,64
ZSS4003640	36	40	152	144	25	299	4,86
ZSS4003840	38	40	160	152	25	344	5,2
ZSS4004040	40	40	168	160	25	394	6,11
ZSS4004540	45	40	188	180	25	536	7,78
ZSS4004840	48	40	200	192	25	638	8,87
ZSS4005040	50	40	208	200	25	710	9,65
ZSS4005240	52	40	216	208	25	795	10,45
ZSS4005540	55	40	228	220	25	913	11,71
ZSS4005740	57	40	236	228	25	1020	12,59
ZSS4006040	60	40	248	240	25	1131	13,97
ZSS4006540	65	40	268	260	25	1220	16,43
ZSS4007040	70	40	288	280	25	1231	19,09
ZSS4007540	75	40	308	300	25	1288	21,94
ZSS4007640	76	40	312	304	30	1303	22,47
ZSS4008040	80	40	328	320	30	1354	24,93
ZSS4008540	85	40	348	340	30	1430	28,18
ZSS4009040	90	40	368	360	30	1500	31,62
ZSS4009540	95	40	388	380	30	1580	35,26
ZSS4010040	100	40	408	400	30	1650	39,11
ZSS4011040	110	40	448	440	30	1744	47,38
ZSS4011440	114	40	464	456	30	1830	50,91

Tab.84

Stahl

Modul 5,0:
Werkstoff: C45
gefräste Zähne
Verzahnungsqualität 8d25
DIN 3967
geradeverzahnt
Eingriffswinkel 20°

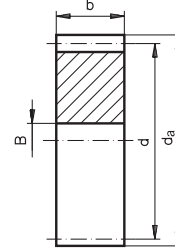
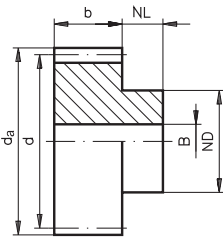

Modul 5,0 – Zahnbreite: 40 mm mit Nabe

Artikel-Nr. mit Nabe	Zähnezahl	b mm	da mm	d mm	NL mm	ND mm	BH7 mm	zul. MD Nm	Gewicht kg
ZSR5001240	12	40	70	60	25	40	15	49	0,99
ZSR5001340	13	40	75	65	25	40	15	54	1,14
ZSR5001440	14	40	80	70	25	50	15	60	1,45
ZSR5001540	15	40	85	75	25	60	15	66	1,79
ZSR5001640	16	40	90	80	25	60	15	72	1,98
ZSR5001740	17	40	95	85	25	60	20	74	2,11
ZSR5001840	18	40	100	90	25	60	20	84	2,33
ZSR5001940	19	40	105	95	25	60	20	97	2,55
ZSR5002040	20	40	110	100	25	60	20	113	2,78
ZSR5002140	21	40	115	105	25	60	20	132	3,03
ZSR5002240	22	40	120	110	25	60	20	152	3,3
ZSR5002340	23	40	125	115	25	60	20	173	3,57
ZSR5002440	24	40	130	120	25	80	20	195	4,29
ZSR5002540	25	40	135	125	25	80	20	219	4,59
ZSR5002640	26	40	140	130	25	80	25	242	4,8
ZSR5002740	27	40	145	135	25	80	25	267	5,13
ZSR5002840	28	40	150	140	25	80	25	293	5,47
ZSR5003040	30	40	160	150	25	80	25	351	6,18
ZSR5003240	32	40	170	160	30	80	25	416	7,14
ZSR5003540	35	40	185	175	30	80	25	526	8,36
ZSR5003640	36	40	190	180	30	100	25	566	9,45
ZSR5003840	38	40	200	190	30	100	25	656	10,33
ZSR5004040	40	40	210	200	30	100	25	750	11,3
ZSR5004540	45	40	235	225	30	100	25	1010	13,87
ZSR5004840	48*	40	250	240	30	100	30	1186	15,44
ZSR5005040	50*	40	260	250	30	120	30	1312	17,5
ZSR5005240	52*	40	270	260	30	120	30	1446	18,75
ZSR5005540	55*	40	285	275	30	150	30	1662	22
ZSR5005640	56*	40	290	280	30	150	30	1739	23
ZSR5006040	60*	40	310	300	30	160	30	1850	26,5

Tab.85

* Diese Räder haben angeschweißte Naben.

Modul 5,0 – Zahnbreite: 40 mm ohne Nabe

Artikel-Nr. ohne Nabe	Zähnezahl	b mm	da mm	d mm	BH7 mm	zul. MD Nm	Gewicht kg
ZSS5002040	20	40	110	100	20	113	2,29
ZSS5002540	25	40	135	125	25	219	3,61
ZSS5003040	30	40	160	150	25	351	5,29
ZSS5003540	35	40	185	175	25	526	7,27
ZSS5003640	36	40	190	180	25	566	7,71
ZSS5003840	38	40	200	190	25	656	8,63
ZSS5004040	40	40	210	200	25	750	9,57
ZSS5004540	45	40	235	225	25	1010	12,15
ZSS5004840	48	40	250	240	30	1186	13,02
ZSS5005040	50	40	260	250	30	1312	13,59
ZSS5005240	52	40	270	260	30	1446	16,28
ZSS5005640	56	40	290	280	30	1739	18,85
ZSS5006040	60	40	310	300	30	1850	22
ZSS5006540	65	40	335	325	30	1953	25,5
ZSS5007040	70	40	360	350	30	2086	30

Tab.86

Modul 5,0 – Zahnbreite: 50 mm mit Nabe

Artikel-Nr. mit Nabe	Zähnezahl	b mm	da mm	d mm	NL mm	ND mm	BH7 mm	zul. MD Nm	Gewicht kg
ZSR5001250	12	50	70	60	25	45	20	58	1,21
ZSR5001350	13	50	75	65	25	50	20	64	1,47
ZSR5001450	14	50	80	70	25	55	20	71	1,76
ZSR5001550	15	50	85	75	25	60	20	79	2,07
ZSR5001650	16	50	90	80	25	65	20	86	2,4
ZSR5001750	17	50	95	85	25	70	20	88	2,75
ZSR5001850	18	50	100	90	25	70	20	100	3,02
ZSR5001950	19	50	105	95	25	70	20	115	3,3
ZSR5002050	20	50	110	100	25	80	20	134	3,83
ZSR5002150	21	50	115	105	25	80	20	157	4,15
ZSR5002250	22	50	120	110	25	80	20	181	4,48
ZSR5002350	23	50	125	115	25	90	20	206	5,08
ZSR5002450	24	50	130	120	25	90	20	232	5,44
ZSR5002550	25	50	135	125	25	90	20	261	5,82
ZSR5002650	26	50	140	130	25	100	20	288	6,5
ZSR5002750	27	50	145	135	25	100	20	318	6,91
ZSR5002850	28	50	150	140	25	100	25	349	7,22
ZSR5002950	29	50	155	145	25	110	25	385	7,98
ZSR5003050	30	50	160	150	25	110	25	418	8,44
ZSR5003250	32	50	170	160	25	110	25	495	9,3
ZSR5005050	50	50	260	250	25	120	30	1561	20,67
ZSR5006050	60	50	310	300	25	160	30	2202	30,69

Tab.87

Modul 5,0 – Zahnbreite: 50 mm ohne Nabe

Artikel-Nr. ohne Nabe	Zähnezahl	b mm	da mm	d mm	BH7 mm	zul. MD Nm	Gewicht kg
ZSS5002050	20	50	110	100	20	134	2,9
ZSS5002450	24	50	130	120	20	232	4,23
ZSS5002550	25	50	135	125	20	261	4,6
ZSS5003050	30	50	160	150	25	418	6,61
ZSS5003250	32	50	170	160	25	495	7,62
ZSS5003550	35	50	185	175	25	626	9,16
ZSS5003850	38	50	200	190	25	781	10,84
ZSS5004050	40	50	210	200	25	893	12,04
ZSS5004550	45	50	235	225	25	1202	15,3
ZSS5004850	48	50	250	240	25	1411	17,44
ZSS5005050	50	50	260	250	30	1561	18,86
ZSS5005250	52	50	270	260	30	1721	20,43
ZSS5005550	55	50	285	275	30	1978	22,89
ZSS5005750	57	50	295	285	30	2030	24,62
ZSS5006050	60	50	310	300	30	2202	27,31
ZSS5006550	65	50	335	325	30	2324	32,12
ZSS5007050	70	50	360	350	30	2482	37,31
ZSS5007550	75	50	385	375	30	2576	42,88
ZSS5007650	76	50	390	380	30	2606	44,04
ZSS5008050	80	50	410	400	30	2708	48,84
ZSS5008550	85	50	435	425	30	2860	55,19
ZSS5009050	90	50	460	450	30	3000	61,92
ZSS5009550	95	50	485	475	30	3160	69,03
ZSS5010050	100	50	510	500	30	3300	76,53
ZSS5011050	110	50	560	550	30	3450	92,69
ZSS5011450	114	50	580	570	30	3600	99,59

Tab.88

Stahl

Modul 6,0:
Werkstoff: C45
gefräste Zähne
Verzahnungsqualität 8d25
DIN 3967
geradeverzahnt
Eingriffswinkel 20°

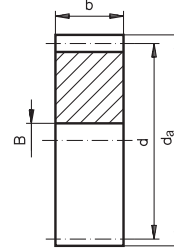
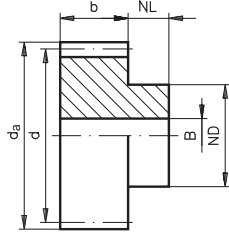

Modul 6,0 – Zahnbreite: 50 mm mit Nabe

Artikel-Nr. mit Nabe	Zähnezahl	b mm	da mm	d mm	NL mm	ND mm	BH7 mm	zul. MD Nm	Gewicht kg
ZSR6001250	12	50	84	72	25	50	20	96	1,72
ZSR6001350	13	50	90	78	25	50	20	112	1,99
ZSR6001450	14	50	96	84	25	60	20	128	2,45
ZSR6001550	15	50	102	90	25	60	20	140	2,79
ZSR6001650	16	50	108	96	25	60	20	145	3,12
ZSR6001750	17	50	114	102	25	60	20	150	3,47
ZSR6001850	18	50	120	108	25	70	20	175	4,05
ZSR6001950	19	50	126	114	25	70	20	207	4,46
ZSR6002050	20	50	132	120	25	70	20	241	4,88
ZSR6002150	21	50	138	126	25	70	25	276	5,24
ZSR6002250	22	50	144	132	25	80	25	312	5,94
ZSR6002350	23	50	150	138	25	80	25	350	6,43
ZSR6002450	24	50	156	144	25	80	25	391	6,93
ZSR6002550	25	50	162	150	25	80	25	436	7,49
ZSR6002650	26	50	168	156	25	80	25	483	8,05
ZSR6002750	27	50	174	162	25	80	25	533	8,62
ZSR6002850	28	50	180	168	25	90	25	587	9,78
ZSR6003050	30	50	192	180	30	100	25	703	11,33
ZSR6003250	32	50	204	192	30	100	25	836	12,74
ZSR6003550	35	50	222	210	30	100	25	1045	14,95
ZSR6003650	36	50	228	216	30	100	25	1120	15,7
ZSR6003850	38	50	240	228	30	110	25	1280	18
ZSR6004050	40*	50	252	240	30	120	30	1460	19,69
ZSR6004550	45*	50	282	270	30	120	30	1955	24,5
ZSR6004850	48*	50	300	288	30	120	30	2300	27,66
ZSR6005050	50*	50	312	300	30	140	30	2550	30,61
ZSR6005250	52*	50	324	312	30	140	30	2800	34,91
ZSR6005550	55*	50	342	330	30	150	40	3060	35,84
ZSR6005650	56*	50	348	336	30	150	40	3120	36,5
ZSR6006050	60*	50	372	360	30	150	40	3350	43

* Diese Räder haben angeschweißte Naben.

Tab.89

Modul 6,0 – Zahnbreite: 50 mm ohne Nabe

Artikel-Nr. ohne Nabe	Zähnezahl	b mm	da mm	d mm	BH7 mm	zul. MD Nm	Gewicht kg
ZSS6002050	20	50	12	120	20	241	4,23
ZSS6002450	24	50	156	144	25	391	6,08
ZSS6002550	25	50	162	150	25	436	6,5
ZSS6003050	30	50	192	180	25	703	9,5
ZSS6003550	35	50	222	210	25	1045	13,14
ZSS6003650	36	50	228	216	25	1120	14
ZSS6004050	40	50	252	240	30	1460	17,5
ZSS6004550	45	50	282	270	30	1955	22
ZSS6004850	48	50	300	288	30	2300	25
ZSS6005050	50	50	312	300	30	2550	27
ZSS6005250	52	50	324	312	30	2800	29,5
ZSS6005650	56	50	348	336	40	3120	34
ZSS6006050	60	50	372	360	40	3350	39

Tab.90

4

Modul 6,0 – Zahnbreite: 60 mm mit Nabe

Artikel-Nr. mit Nabe	Zähnezahl	b mm	da mm	d mm	NL mm	ND mm	BH7 mm	zul. MD Nm	Gewicht kg
ZSR6001260	12	60	84	72	20	54	20	110	1,82
ZSR6001360	13	60	90	78	20	60	20	129	2,2
ZSR6001460	14	60	96	84	20	65	20	147	2,88
ZSR6001560	15	60	102	90	20	70	20	161	3,01
ZSR6001660	16	60	108	95	20	75	20	167	3,46
ZSR6001760	17	60	114	102	20	75	20	172	4,26
ZSR6001860	18	60	120	108	20	80	20	201	4,33
ZSR6002060	20	60	132	120	20	90	20	277	5,43
ZSR6002160	21	60	138	126	20	90	25	317	6,44
ZSR6002260	22	60	144	132	20	100	25	358	7,23
ZSR6002460	24	60	156	144	20	110	25	450	7,88
ZSR6002560	25	60	162	150	20	110	25	500	8,42
ZSR6003060	30	60	192	180	20	120	25	808	13,2
ZSR6003660	36	60	228	216	20	130	25	1284	18,68
ZSR6005060	50	60	312	300	20	140	30	2924	34,59
ZSR6006060	60	60	372	360	20	150	40	3842	48,97

Tab.91

Modul 6,0 – Zahnbreite: 60 mm ohne Nabe

Artikel-Nr. ohne Nabe	Zähnezahl	b mm	da mm	d mm	BH7 mm	zul. MD Nm	Gewicht kg
ZSS6002060	20	60	132	120	20	277	5,08
ZSS6002460	24	60	156	144	25	450	7,29
ZSS6002560	25	60	162	150	25	500	7,93
ZSS6002860	28	60	180	168	25	675	8,41
ZSS6003060	30	60	192	180	25	808	9,69
ZSS6003260	32	60	204	192	25	960	11,05
ZSS6003560	35	60	222	210	25	1200	13,27
ZSS6003660	36	60	228	216	25	1284	16,69
ZSS6003860	38	60	240	228	25	1470	15,69
ZSS6004060	40	60	252	240	25	1680	17,42
ZSS6005060	50	60	312	300	30	2924	32,31
ZSS6006060	60	60	372	360	40	3842	46,42

Tab.92

Stahl

Modul 8,0:

Werkstoff: C45
 gefräste Zähne
 Verzahnungsqualität 8d25
 DIN 3967
 geradeverzahnt
 Eingriffswinkel 20°

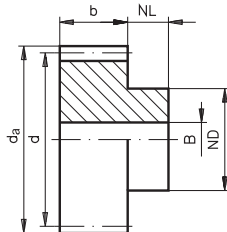

Modul 8,0 – Zahnbreite: 65 mm mit Nabe

Artikel-Nr. mit Nabe	Zähnezahl	b mm	da mm	d mm	NL mm	ND mm	BH7 mm	zul. MD Nm	Gewicht kg
ZSR8001265	12	65	112	96	30	70	25	240	4,2
ZSR8001565	15	65	136	120	30	80	25	370	6,5
ZSR8001865	18	65	160	144	30	80	25	495	9
ZSR8002065	20	65	176	160	30	100	30	655	11,5
ZSR8002465	24	65	208	192	30	120	30	1045	16,9
ZSR8002565	25	65	216	200	30	120	30	1160	18,1
ZSR8003065	30	65	256	240	30	150	30	1834	26,6
ZSR8003665	36	65	304	288	30	160	40	2900	36,9
ZSR8004065	40*	65	336	320	30	180	40	3790	46

Tab.93

* Diese Räder haben angeschweißte Naben.

Edelstahl

Werkstoff: 1.4305 rostfrei/INOX
 gefräste Zähne
 Verzahnungsqualität 8d25
 DIN 3967
 geradeverzahnt
 Eingriffswinkel 20°

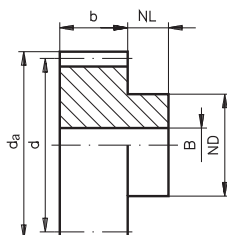

Modul 1,0 – Zahnbreite: 10 mm mit Nabe

Artikel-Nr. mit Nabe	Zähnezahl	b mm	da mm	d mm	NL mm	ND mm	BH7 mm	zul. MD Ncm	Gewicht g
ZSR1001010I	10	10	12	10	6	8	4	11	7
ZSR1001110I	11	10	13	11	6	8	4	14	8
ZSR1001210I	12	10	14	12	6	10	4	15	10
ZSR1001310I	13	10	15	13	6	10	5	18	11
ZSR1001410I	14	10	16	14	6	10	5	19	14
ZSR1001510I	15	10	17	15	6	12	5	21	16
ZSR1001610I	16	10	18	16	6	12	5	22	18
ZSR1001710I	17	10	19	17	6	12	6	23	19
ZSR1001810I	18	10	20	18	6	15	6	26	24
ZSR1001910I	19	10	21	19	6	15	6	30	26
ZSR1002010I	20	10	22	20	6	15	6	33	28
ZSR1002210I	22	10	24	22	6	15	6	42	33
ZSR1002410I	24	10	26	24	6	15	6	51	39
ZSR1002510I	25	10	27	25	6	20	8	56	46
ZSR1002610I	26	10	28	26	6	20	8	61	49
ZSR1002810I	28	10	30	28	6	20	8	72	55
ZSR1003010I	30	10	32	30	8	25	8	84	77
ZSR1003610I	36	10	38	36	8	25	8	127	102
ZSR1004010I	40	10	42	40	8	25	8	162	120
ZSR1004510I	45	10	47	45	10	30	10	211	165
ZSR1004810I	48	10	50	48	10	30	10	244	182
ZSR1005010I	50	10	52	50	10	30	10	268	193
ZSR1005410I	54	10	56	54	10	40	10	319	262
ZSR1006010I	60	10	62	60	12	40	10	405	320
ZSR1006410I	64	10	66	64	12	40	10	469	352
ZSR1006510I	65	10	67	65	12	40	10	486	360
ZSR1007010I	70	10	72	70	12	40	10	576	401
ZSR1007210I	72	10	74	72	12	50	10	614	484
ZSR1007510I	75	10	77	75	12	50	10	674	510
ZSR1008010I	80	10	82	80	12	50	10	782	560
ZSR1010010I	100	10	102	100	12	60	12	1310	856
ZSR1012010I	120	10	122	120	12	60	12	2150	1125

Tab.94

Modul 1,5 – Zahnbreite: 15 mm mit Nabe

Artikel-Nr. mit Nabe	Zähnezahl	b mm	da mm	d mm	NL mm	ND mm	BH7 mm	zul. MD Ncm	Gewicht g
ZSR1501115I	11	15	19,5	16,5	10	12	6	47	28
ZSR1501215I	12	15	21	18	10	15	8	55	32
ZSR1501415I	14	15	24	21	10	15	8	69	42
ZSR1501515I	15	15	25,5	22,5	10	18	10	76	49
ZSR1501615I	16	15	27	24	10	20	10	83	60
ZSR1501715I	17	15	28,5	25,5	10	20	10	89	66
ZSR1501815I	18	15	30	27	10	22	10	96	79
ZSR1502015I	20	15	33	30	10	25	10	123	103
ZSR1502215I	22	15	36	33	15	25	10	153	136
ZSR1502415I	24	15	39	36	15	25	10	188	154
ZSR1502515I	25	15	40,5	37,5	15	25	10	207	166
ZSR1502815I	28	15	45	42	15	25	10	269	198
ZSR1503015I	30	15	48	45	15	30	10	314	246
ZSR1503515I	35	15	55,5	52,5	15	30	10	447	317
ZSR1504015I	40	15	63	60	15	40	10	606	454
ZSR1504515I	45	15	70,5	67,5	15	40	10	793	541
ZSR1504815I	48	15	75	72	15	40	10	920	599
ZSR1505015I	50	15	78	75	15	50	10	1010	721
ZSR1505515I	55	15	85,5	82,5	15	50	10	1260	831
ZSR1506015I	60	15	93	90	15	60	12	1540	1041
ZSR1506515I	65	15	100,5	97,5	15	60	12	1850	1172
ZSR1507015I	70	15	108	105	20	60	12	2190	1423
ZSR1508015I	80	15	123	120	20	70	15	2990	1878

Tab.95